

Proximity focusing RICH with flat pannel PMTs as photon detector

Peter Križan

University of Ljubljana and J. Stefan Institute

For Belle Aerogel RICH R&D group



Contents

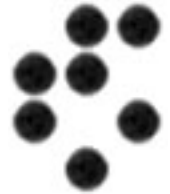

Motivation and requirements

Beam test results

Optimisation of counter parameters

Summary



PID upgrade in the forward direction

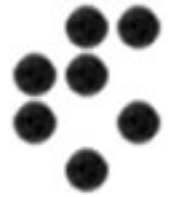

improve π/K separation in the forward (high momentum) region for few-body B decays

good p/K separation for $b \rightarrow d \gamma$, $b \rightarrow s \gamma$

improve purity in fully reconstructed B decays ('full recon. tag')

low momentum ($<1\text{GeV}/c$) $e/\mu/\pi$ separation (B \rightarrow Kll)

keep high the efficiency for tagging kaons

→ talk by Toru Iijima on Belle PID upgrade (Friday)



PID upgrade in the forward direction

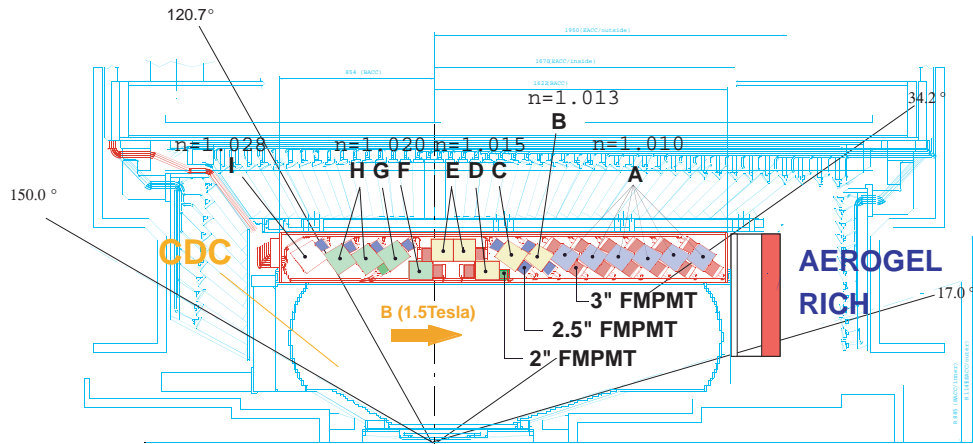
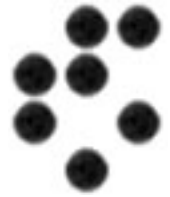

Proximity focusing RICH with aerogel as radiator

K/π separation at 4 GeV/c

$$\theta_c(\pi) \sim 308 \text{ mrad} \quad (n = 1.05)$$

$$\theta_c(\pi) - \theta_c(K) \sim 23 \text{ mrad}$$

$$\delta\theta_c(\text{meas.}) \sim 12 \text{ mrad}$$

With 20mm thick aerogel and 6mm PMT pad size

→ 6σ separation with $N_{pe} \sim 10$

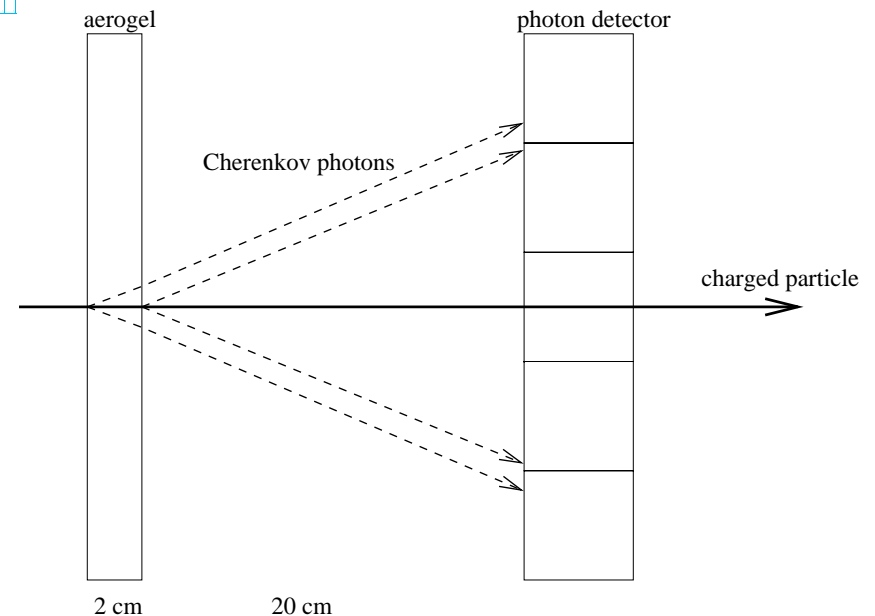



Beam tests

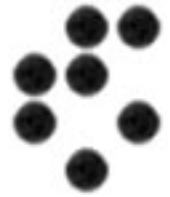

Beam Test Nov. 2001

36 MAPMTs (R5900-M16) @ 30mm pitch,
36% eff. area, 192 readout channels

single photon Cherenkov angle resolution
better than 10mrad

number of photons consistent with
expectations, but clearly too low

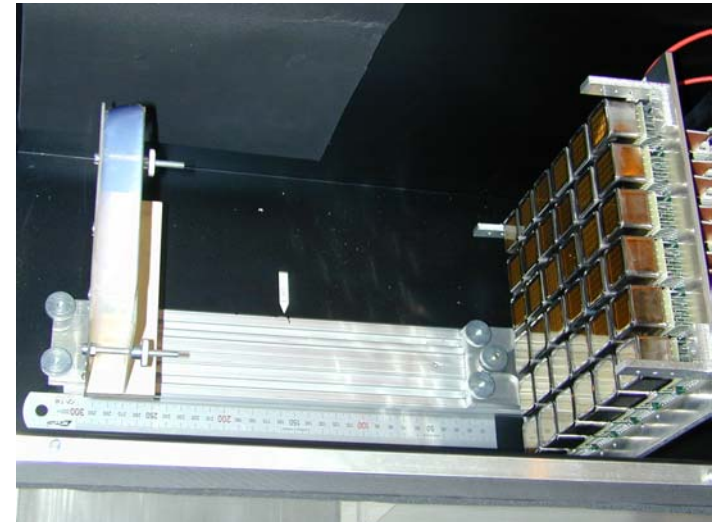

Beam tests Nov. 2002 - 2004

new aerogel samples

new photon detector Hamamatsu H8500 (flat pannel PMT)

new readout electronics (1024 channels)



Hamamatsu H8500 (flat panel PMT) as photon detector

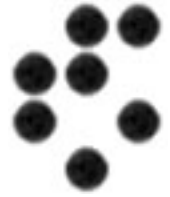

- 8x8 multi-anode PMT (64ch) by HPK
- **Effective area=89%** (\square 49mm for \square 51.7mm package)
- 4x4 array used in beam tests (1024 ch in total)

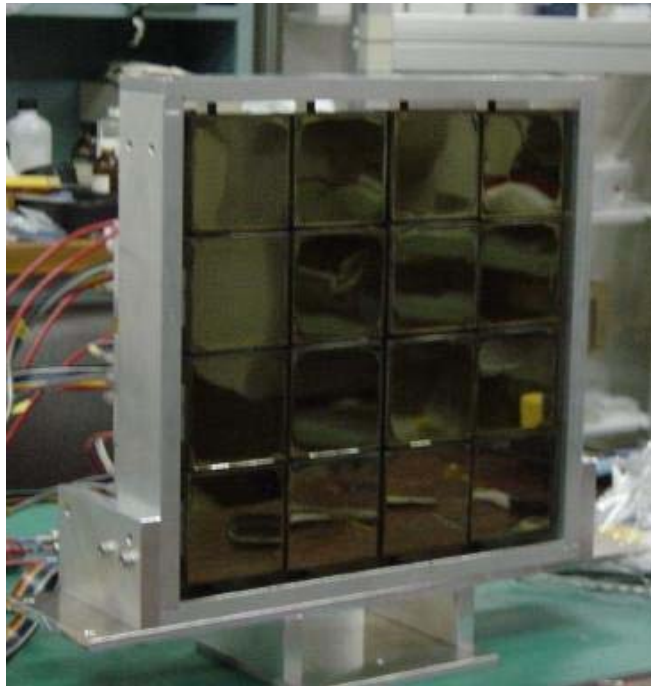

Not suitable for operation in magnetic field, but still good for the understanding of the detector behavior → **intermediate step in our R+D**

→ talks by Takayuki Sumiyoshi and Andrej Gorišek

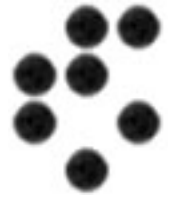

Read-out electronics

- IC's with analog memory
- 2 analog memory chips for 1 PMT (each for 32ch)
- 8 step pipe-line ($1\mu\text{s} \times 8$)
- Serial signal sent to VME ADC ($10\mu\text{s}$ period \times 256ch)
- Use 4 VME ADC channels for 1024 ch readout

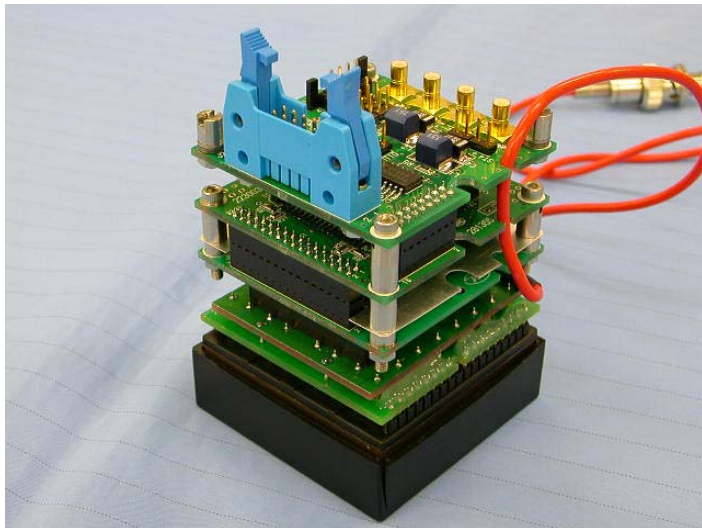

Assembled flat
panel PMT with read-out

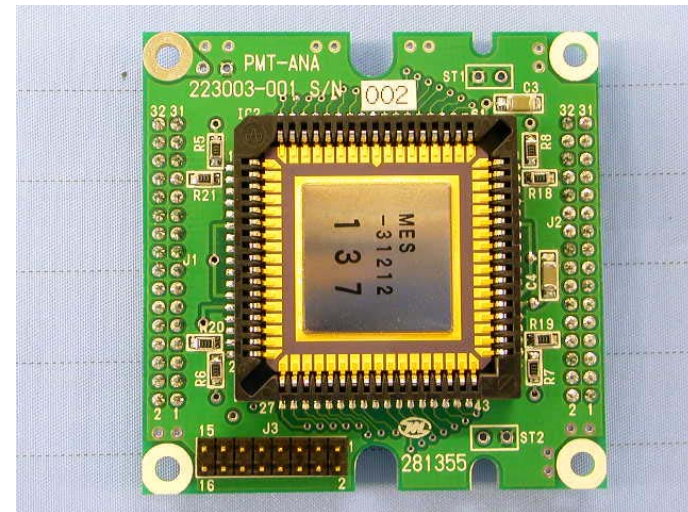

Analog memory board



Beam test set-up



π^- beam
→
0.5 to 4.0 GeV/c

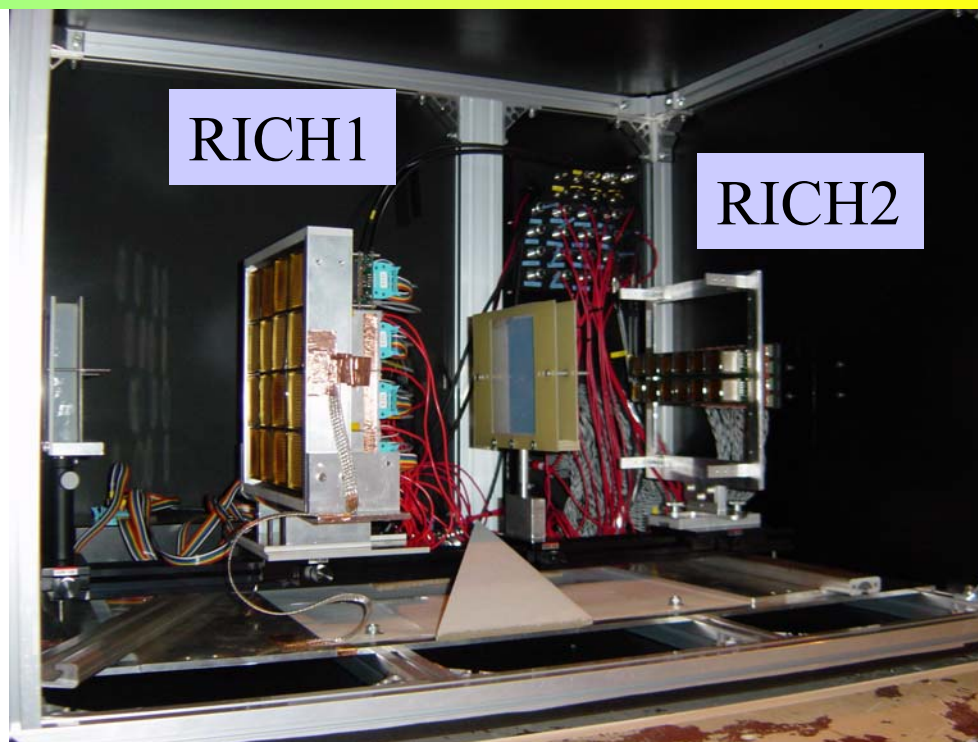

- RICH1: Flat panel PMTs and aerogel radiator
- MWPCs for tracking
- RICH2: as a reference (with R5900-M16 PMTs)
- CO₂ threshold Gas Cherenkov counter for electron veto



Beam test results

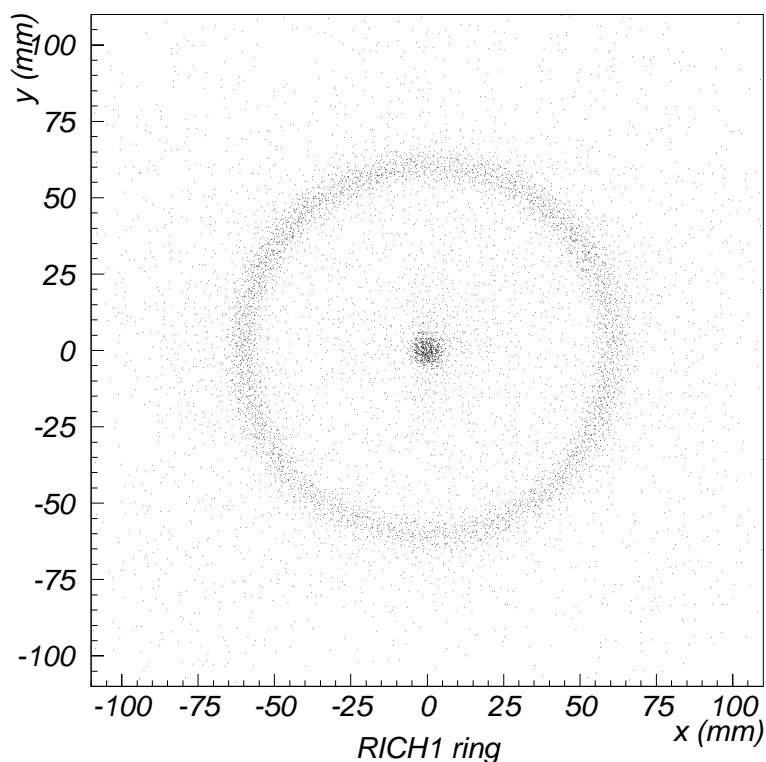

Accumulated hits

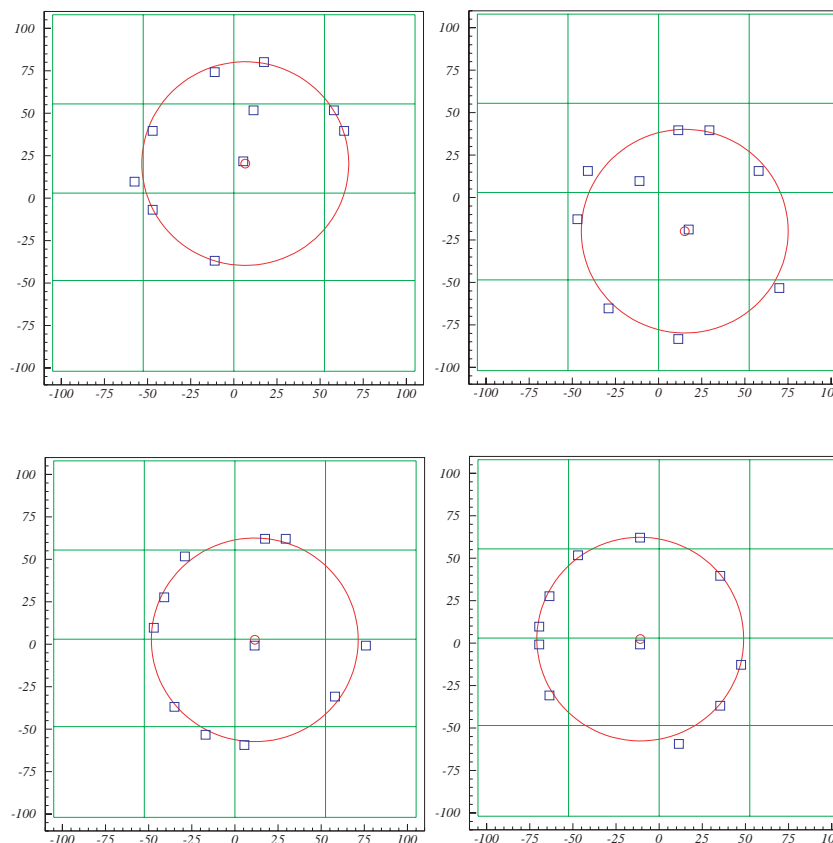

Clear rings, little background



Cherenkov angle resolution and number of photons

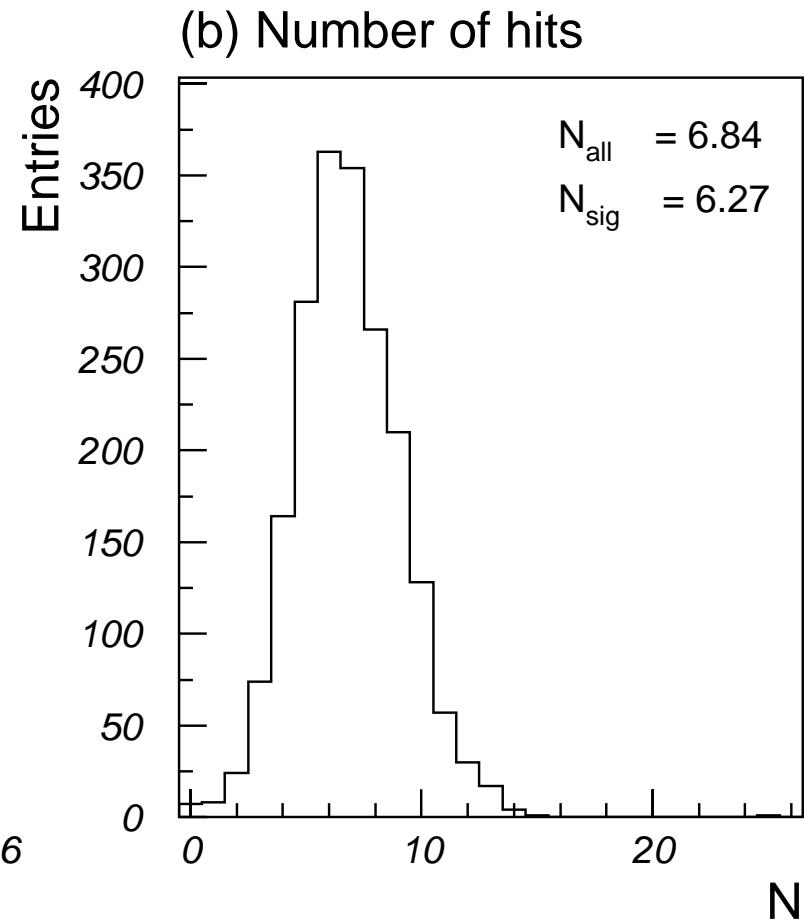
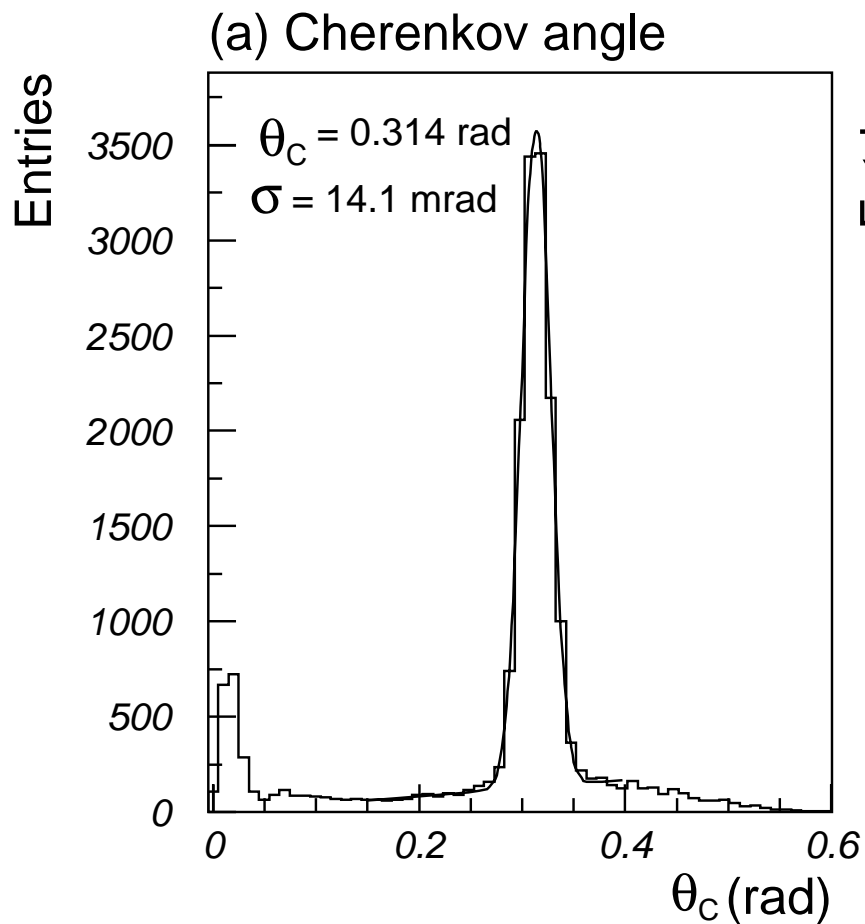
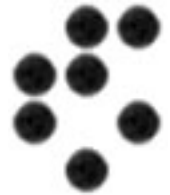



Resolution for single photons

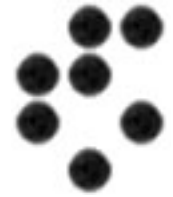

Typically around 13 mrad (for 2 cm thick aerogel)
Shown as a function of thickness, momentum

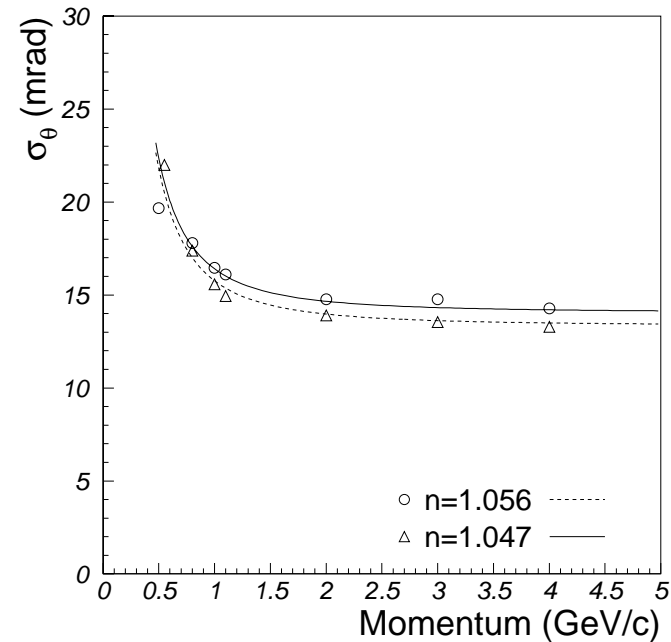
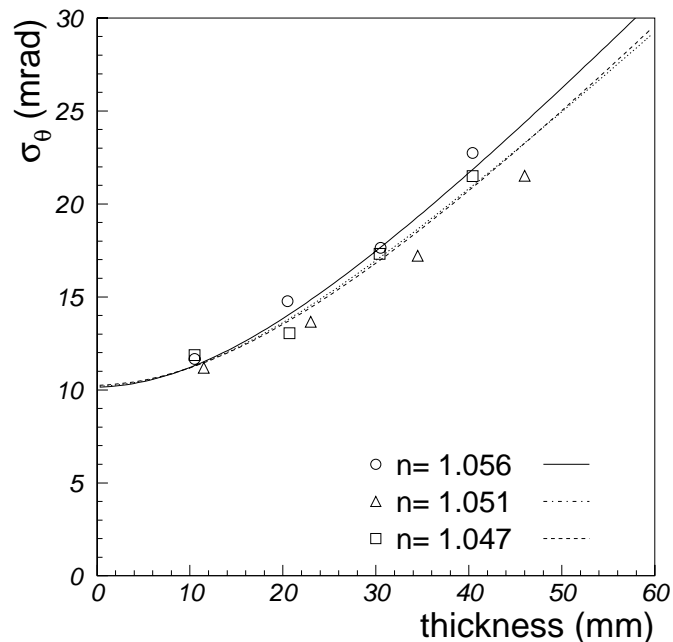



Number of photons

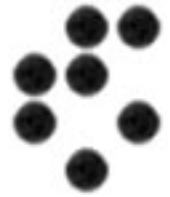

As a function of momentum, thickness, transmission length

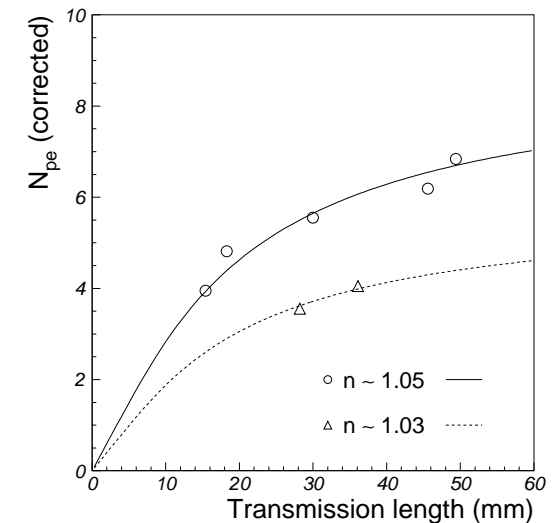
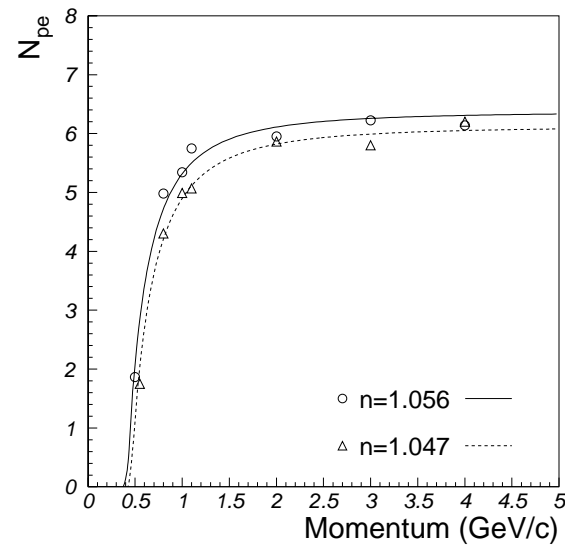
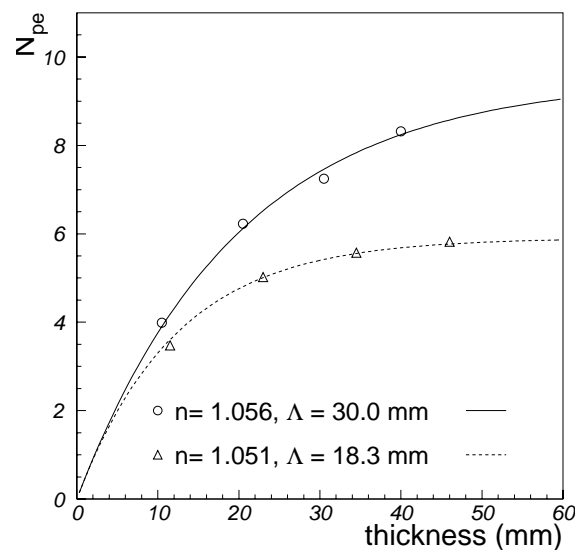

In good agreement with expectations.

Can we increase the number of photons by keeping the good single photon resolution?

→ talk by Samo Korpar



PID capability on test beam data

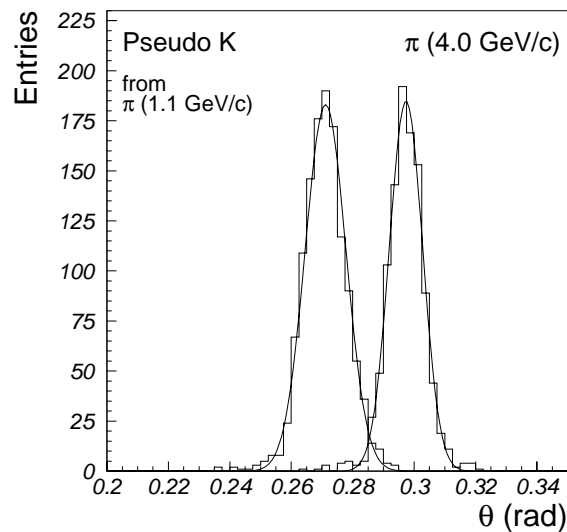
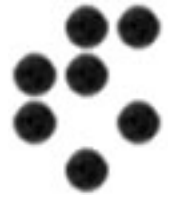

From typical values (single photon resolution 13mrad and 6 detected photons) we can estimate the Cherenkov resolution per track:
5.3mrad

-> 4.3 sigma π /K separation at 4GeV/c.

Illustration of PID performance: Cherenkov angle distribution for pions at 4GeV/c and 'kaons' (pions at 1.1GeV/c with the same Cherenkov angle as kaons at 4GeV/c).

Details on the beam test: NIM A521 (2004) 367 (physics/0309032)

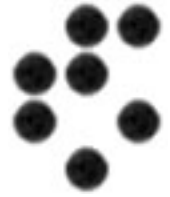

Resolution studies

σ_θ is obtained by fitting the θ distribution Gaussian + background

Cherenkov angle distribution

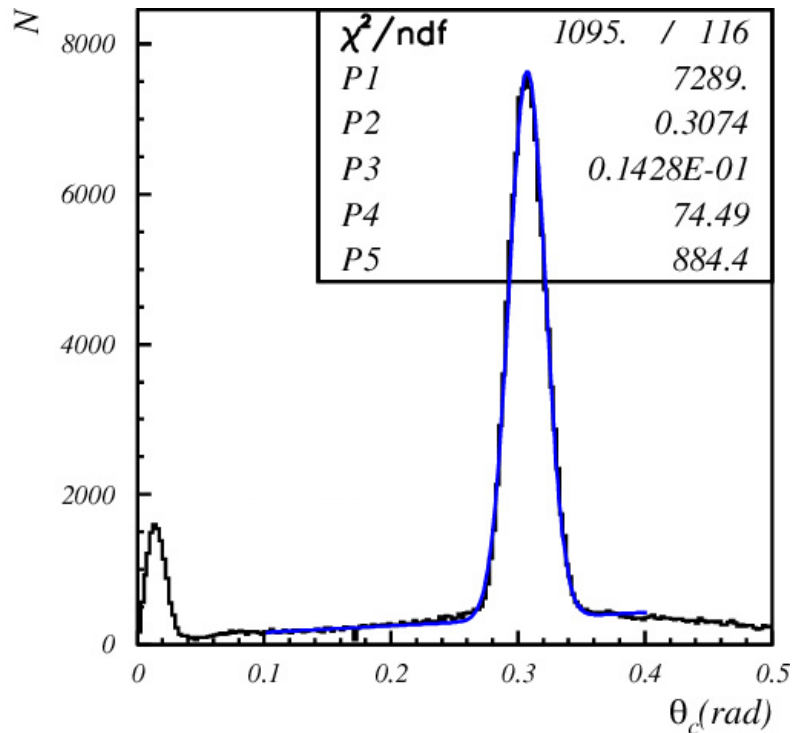

Radiator: thickness 20.5mm

σ_θ (data)=14.3mrad

$$\sigma_\theta(\text{calc}) = \sqrt{\sigma_{\text{emp}}^2 + \sigma_{\text{pix}}^2}$$

$\sigma(\text{calc})$	11.8 mrad
σ_{pix}	7.8 mrad
σ_{emp}	8.8 mrad

$$\sigma_\theta = \sqrt{\sigma_{\text{emp}}^2 + \sigma_{\text{pix}}^2 + \sigma_{\text{rest}}^2}$$

What is rest?



Resolution studies 2

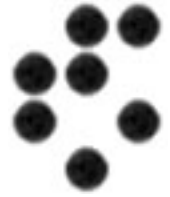

- σ_{θ} (data) : Data(n=1.046)
- σ_{calc} : Calculated value $(\sigma_{\text{pix}}^2 + \sigma_{\text{emp}}^2)^{1/2}$
- ▼ σ_{rest} : $(\sigma_{\text{data}}^2 - \sigma_{\text{calc}}^2)^{1/2}$

Rest component $\sigma_{\text{rest}} = 7 \sim 8$ mrad
 doen not depend on radiator thickness

Cherenkov angle resolution

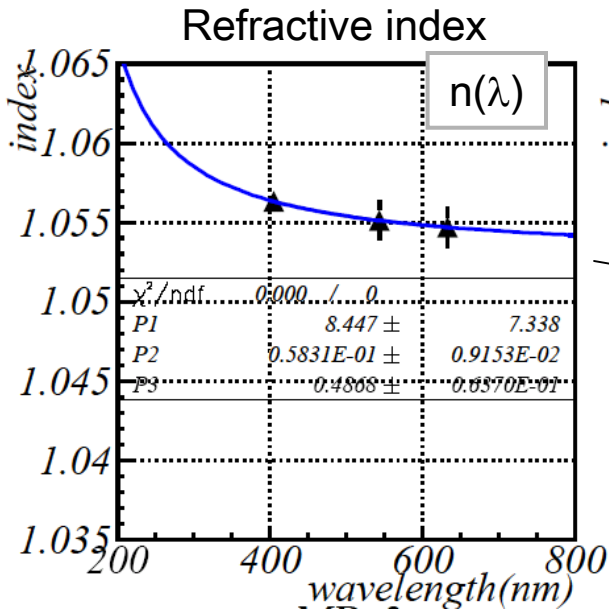
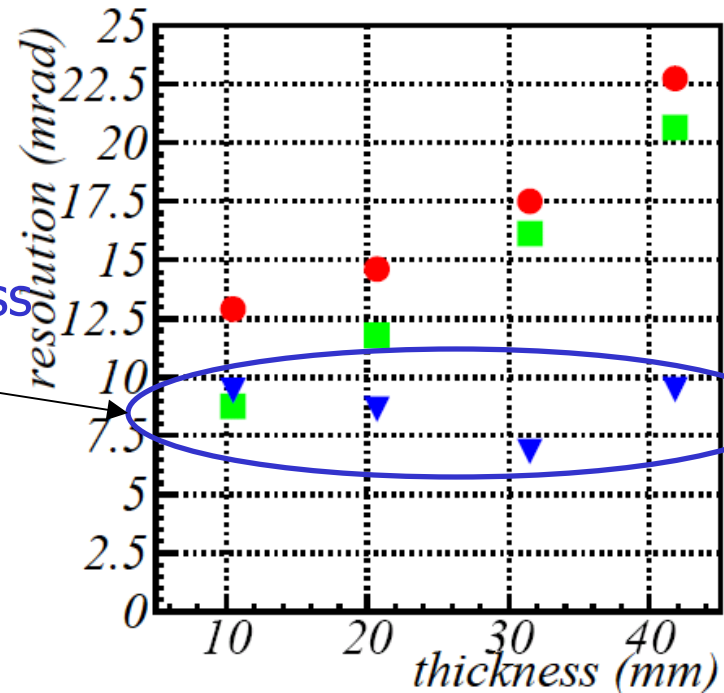

Chromatic error? 2-3 mrad (depends on the sample)



Resolution studies 3

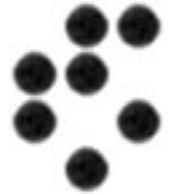

Non-uniformity of the radiator? Group tracks according to the impact position in 5mmx5mm regions, plot Cherenkov angle distribution for each of them:

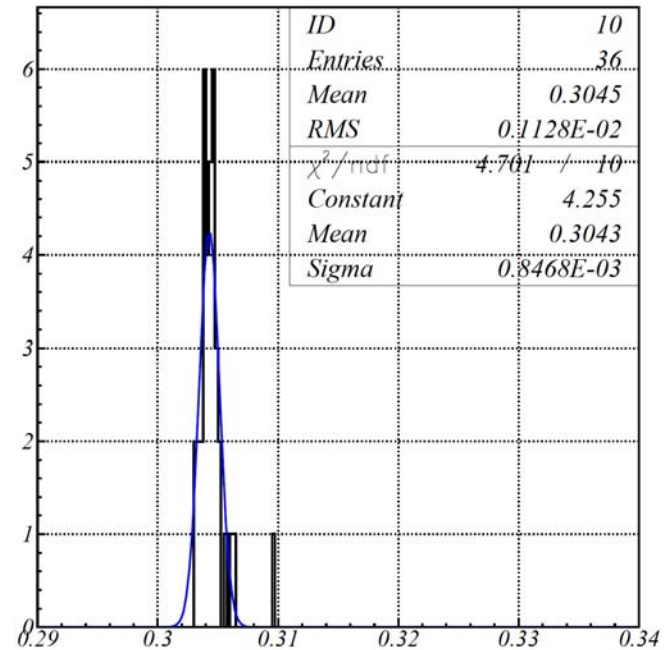
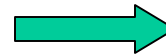

Cherenkov angle variation due to non-uniformity of aerogel: **1 mrad**

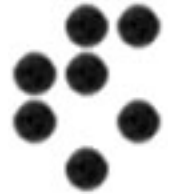

Resolution studies 4

Does it depend on the orientation of the sample?

Measure the Cherenkov angle and sigma for both orientations of the aerogel tile
→some samples have large difference in sigma for AB and BA cases

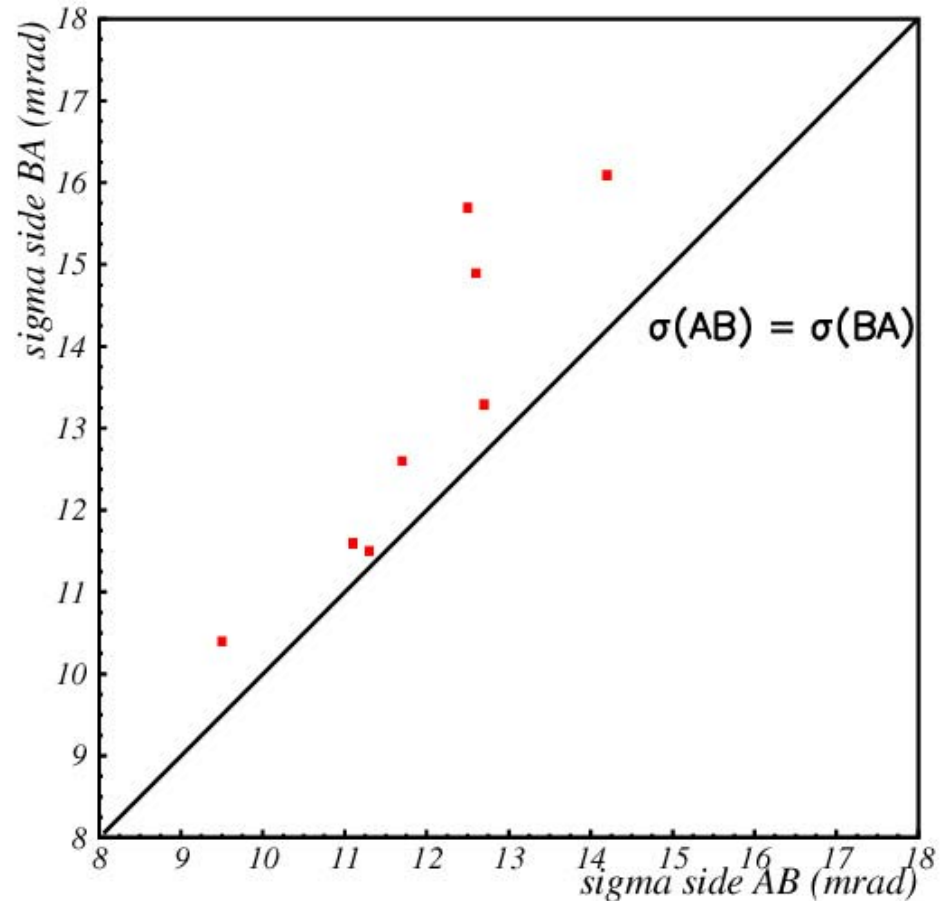
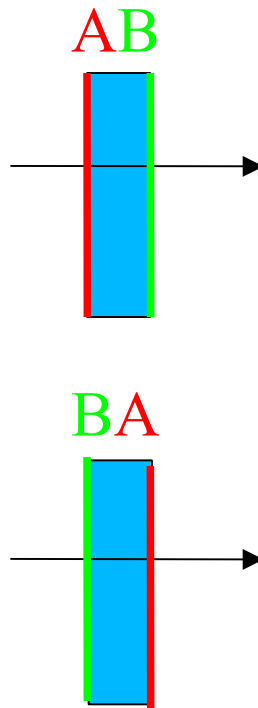

Is it focusing/defocusing? →under study



Radiator tiling scheme

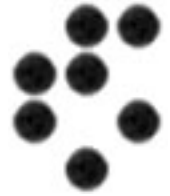

How to design radiator tiles: determine losses at the tile boundary.

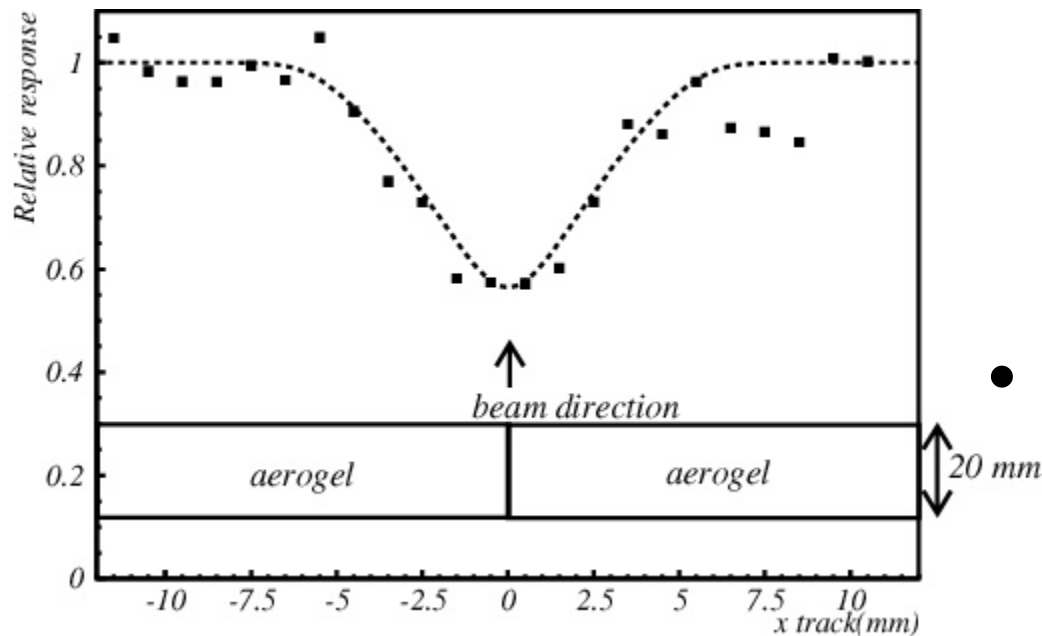

- Scan with the beam across the tile boundary. As expected, the yield is affected over a few mm in the vicinity of the boundary.
- A simple model (all photons hitting the boundary get lost) accounts for most of the dependence →

Reduce the fraction of tracks close to tile boundaries and corners



Summary

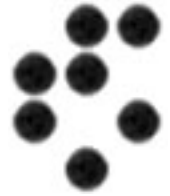

- Proximity focusing RICH with aerogel as radiator looks as a very promising option for the PID system upgrade of the endcap part of the Belle detector
- Flat panel PMT is an excellent single photon detector, suitable for RICH counters in absence of magnetic field
- Efficiently used to test design options of the Belle endcap PID upgrade, understanding of the system, improved aerogel samples and configurations, read-out systems under development.
- R&D issues for Belle endcap upgrade: development and testing of a multichannel photon detector for high mag. fields
- Mass production of large aerogel tiles
- Readout electronics



Back-up slides

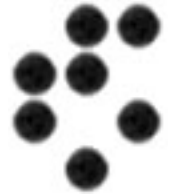

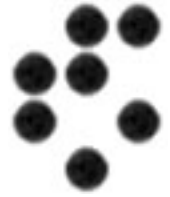

Surface uniformity

Study uniformity of the sensitivity over the surface

- source: LED in the eyepiece of a microscope on a 2d stage
- spot size $50 \mu\text{m}$

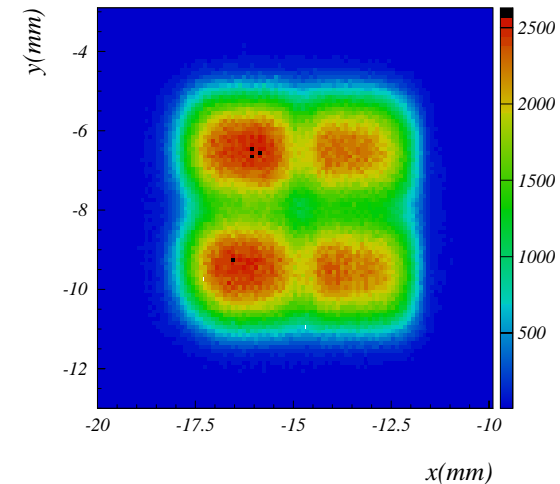
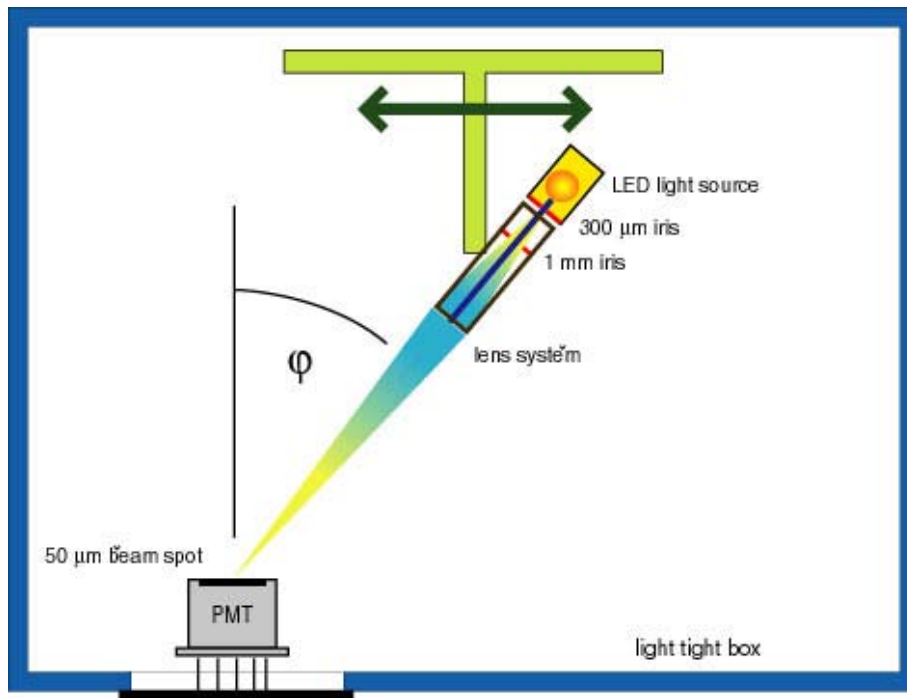

Single channel response of the H8500 PMT



Read-out electronics

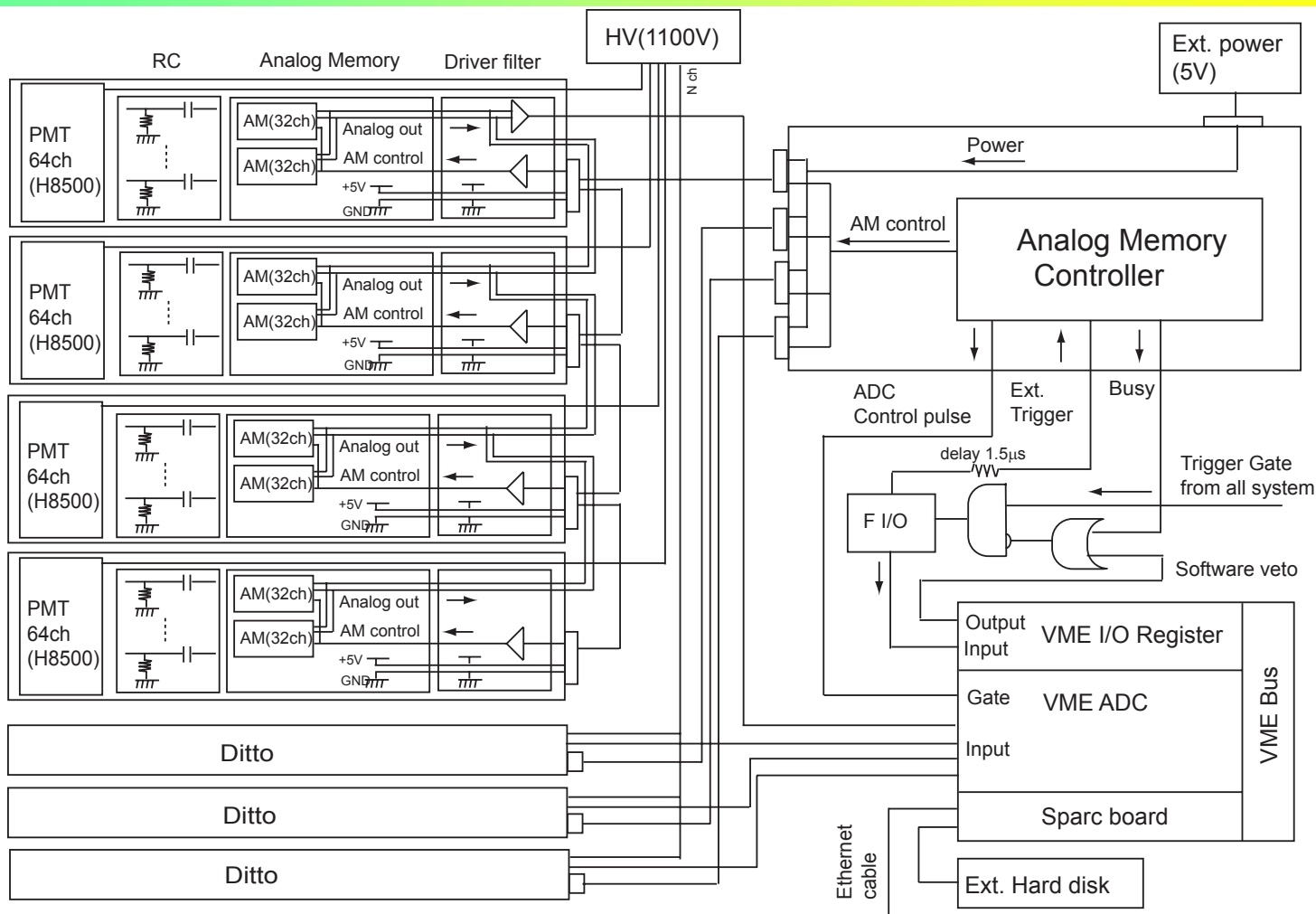

* System developed by Meisei Co.