

LHCb Week, September 7, 2020

Belle II - Status and Plans

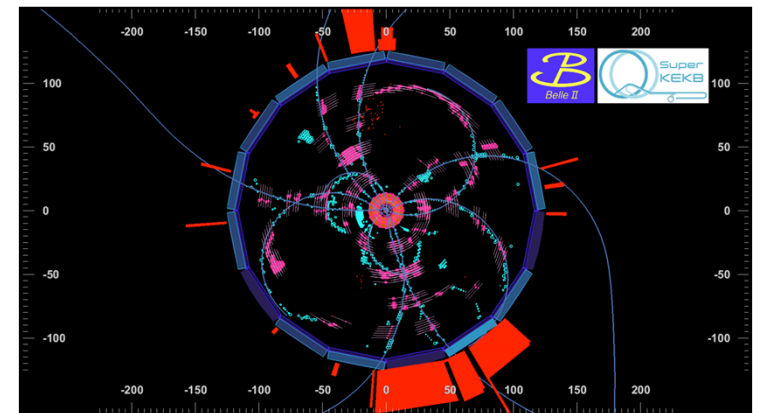

Univerza v Ljubljani
Fakulteta za *matematiko in fiziko*

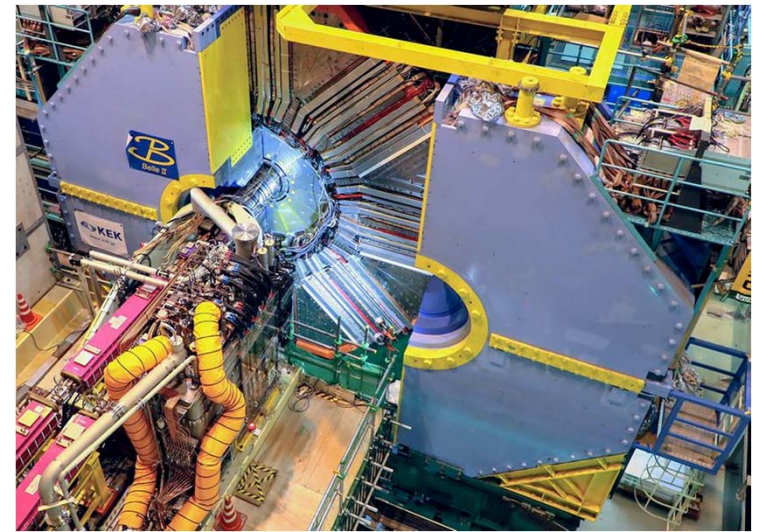

Peter Križan
*University of Ljubljana
and J. Stefan Institute*

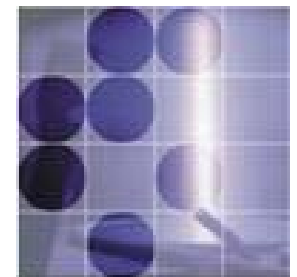



Contents



- Why a super B factory, and how?
- SuperKEKB and Belle II
- Belle II: first results
- Outlook

B meson production at $\Upsilon(4S)$

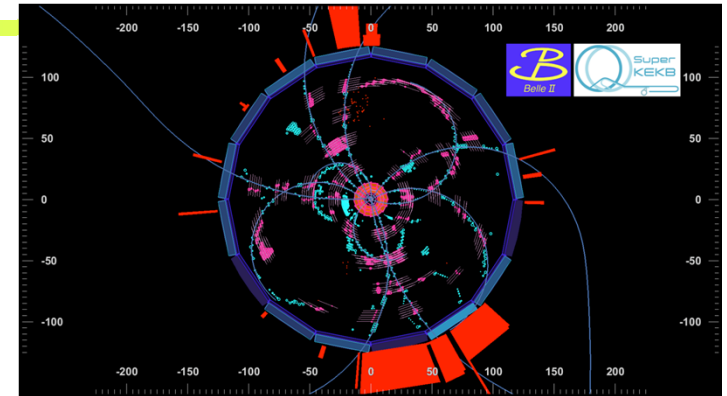
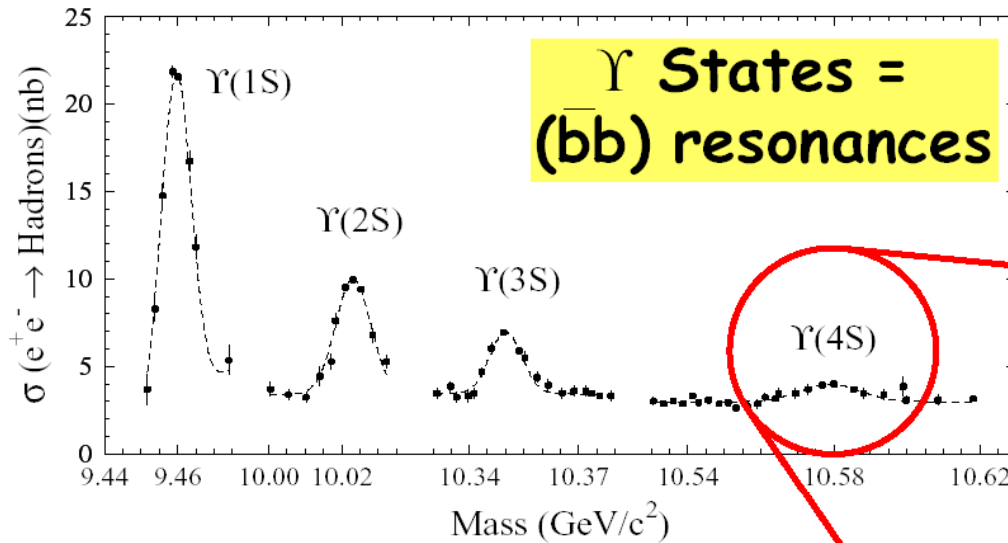

Cross Sections at $\Upsilon(4S)$:

$b\bar{b} \sim 1.1$ nb

$c\bar{c} \sim 1.3$ nb

$d\bar{d}, s\bar{s} \sim 0.3$ nb

$u\bar{u} \sim 1.4$ nb

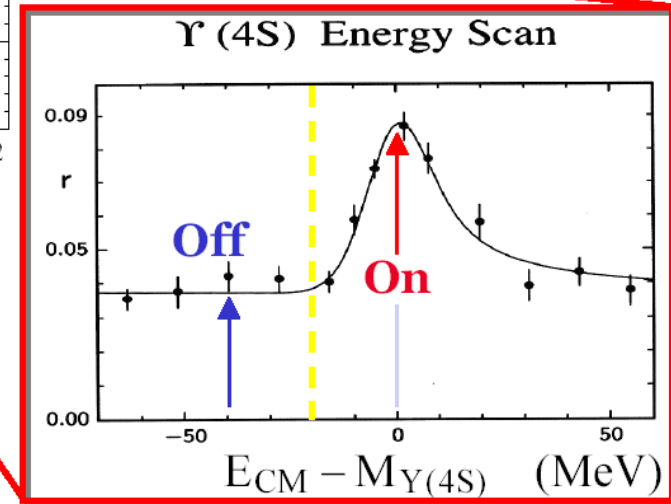

$e^+e^- \rightarrow \Upsilon(4S) \rightarrow B\bar{B}$
 $L=1$ state

Advantages of a B factory in the LHC era

Fantastic performance of LHCb 😊

Still, an e^+e^- machine running at (or near) $\Upsilon(4S)$ is complementary to LHCb in several aspects.

Unique capabilities of a B factory:

- Exactly two B mesons produced
- High flavour tagging efficiency
- Detection of gammas, π^0 s, K_L s
- Very clean detector environment (decays with several neutrinos in the final state, tau physics, dark sector)

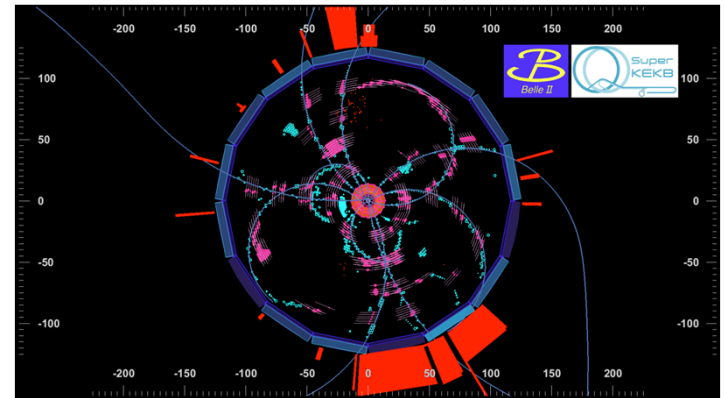

Physics potential summarized in Belle II Theory Interface Platform (B2TiP) 'physics book' PTEP 2019 (2019) 12, arXiv:1808.10567

However, need a two-orders-of-magnitude larger data sample!

Peter Krizan, Ljubljana

Need O(100x) more data → Next generation B-factory

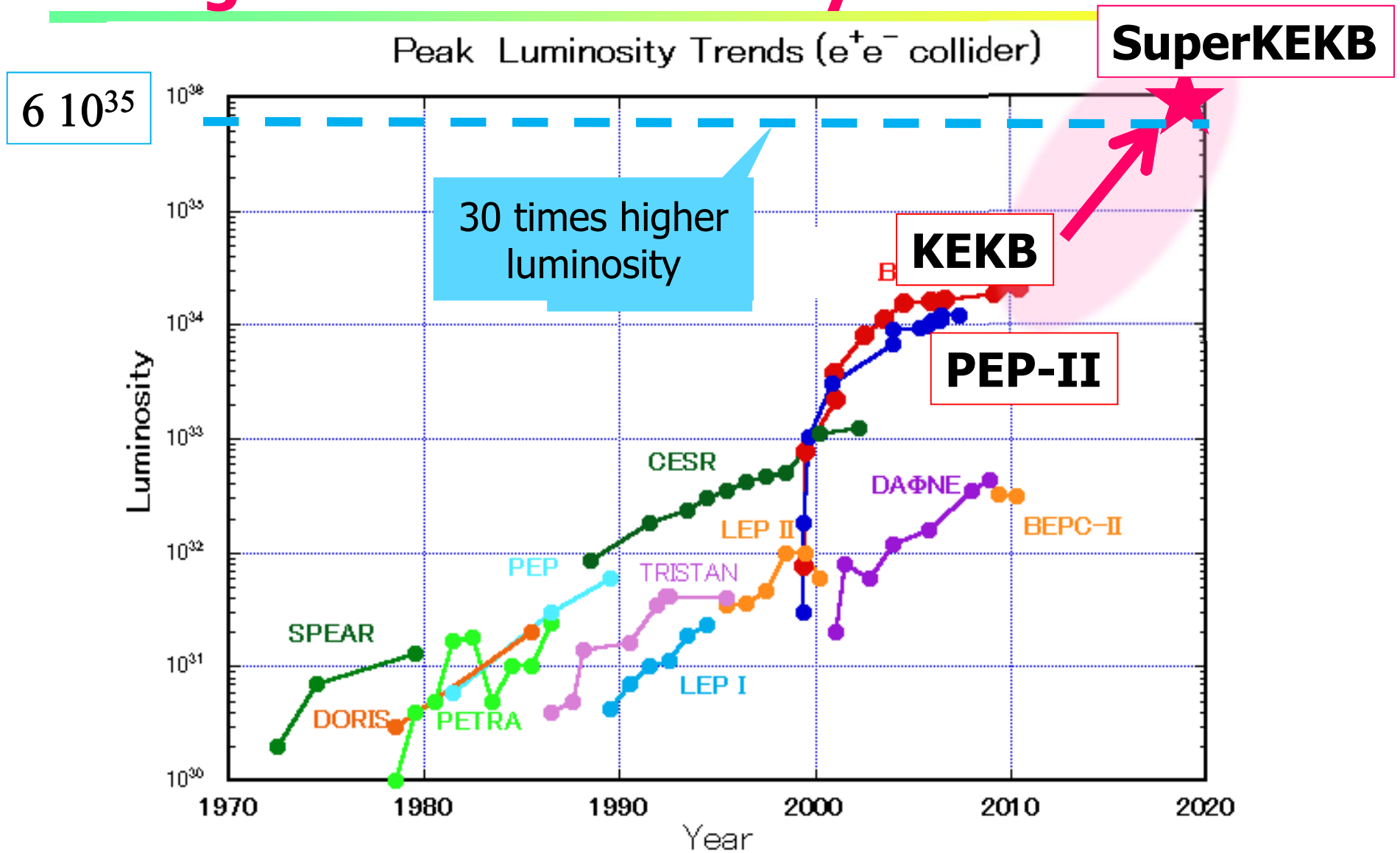

N.B. KEKB peak L: $2.11 \cdot 10^{34} \text{ cm}^{-2} \text{ s}^{-1}$

Peter Križan, Ljubljana

How to increase the luminosity?

$$L = \frac{\gamma_{e\pm}}{2er_e} \left(1 + \frac{\sigma_y^*}{\sigma_x^*} \right) \left(\frac{I_{e\pm} \xi_{\zeta y}^{e\pm}}{\beta_y^*} \right) \left(\frac{R_L}{R_{\xi_y}} \right)$$

Lorentz factor $\gamma_{e\pm}$
 Beam current $I_{e\pm}$
 Beam-beam parameter $\xi_{\zeta y}^{e\pm}$
 Classical electron radius r_e
 Beam size ratio@IP $\frac{\sigma_y^*}{\sigma_x^*}$ (1 - 2 % (flat beam))
 Vertical beta function@IP β_y^*
 Lumi. reduction factor (crossing angle) & Tune shift reduction factor (hour glass effect) $\frac{R_L}{R_{\xi_y}}$ (0.8 - 1 (short bunch))

- (1) Smaller β_y^*
 - (2) Increase beam currents
 - (3) Increase $\xi_{\zeta y}$
- “Nano-Beam” scheme**

Collision with very small spot-size beams

Invented by Pantaleo Raimondi for SuperB

How big is a nano-beam ?



How to go from an excellent accelerator with world record performance – KEKB – to a 30x times better, more intense facility?

In KEKB, colliding electron and positron beams were already **much thinner than a human hair...**

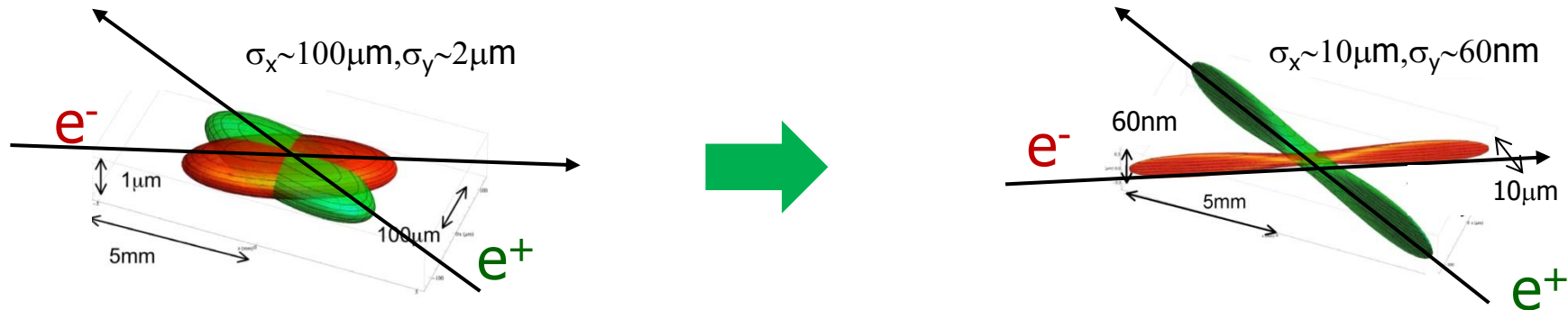

... For a 30x increase in intensity you have to make the beam as thin as a **few x100 atomic layers!**

To get x40 higher luminosity

KEKB → SuperKEKB



Replace short dipoles with longer ones (LER)

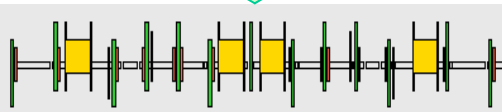
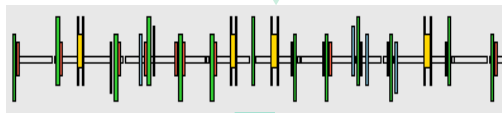

Redesign the lattices of HER & LER to squeeze the emittance

TiN-coated beam pipe with antechambers

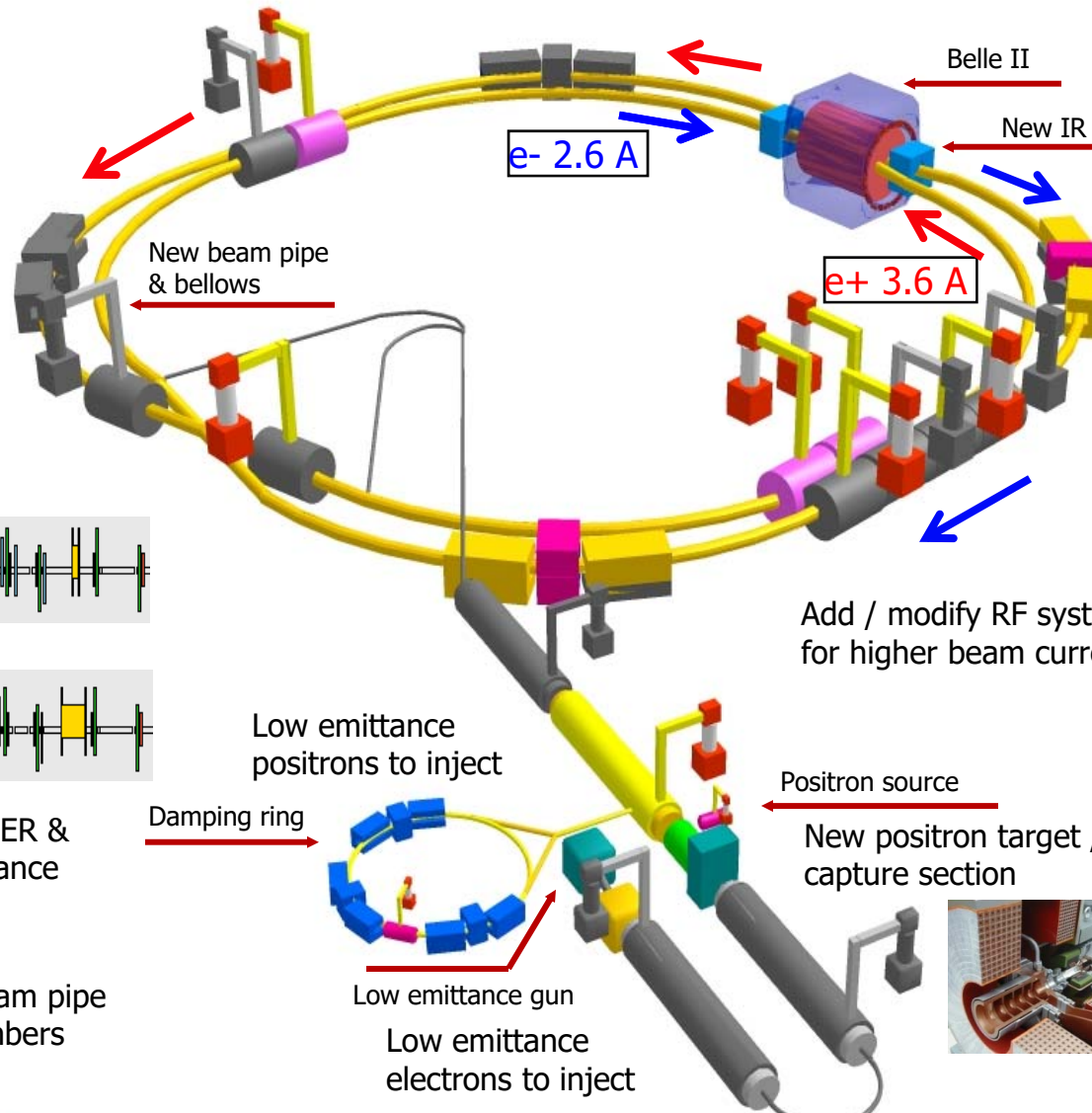
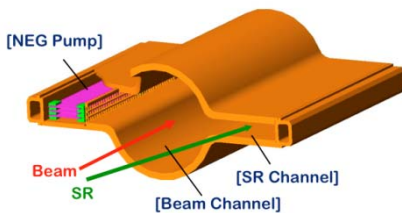

Colliding bunches

New superconducting / permanent final focusing quads near the IP

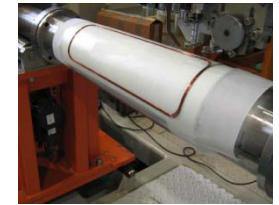

Add / modify RF systems for higher beam current



Positron source

New positron target / capture section



SuperKEKB, the first new collider in particle physics since the LHC





Requirements for the Belle II detector

Critical issues at $L = 3 \times 10^{35}/\text{cm}^2/\text{sec}$

- ▶ **Higher background ($\times 10\text{-}20$)**
 - radiation damage and occupancy
 - fake hits and pile-up noise in the EM
- ▶ **Higher event rate ($\times 10$)**
 - higher rate trigger, DAQ and computing
- ▶ **Require special features**
 - low $p \mu$ identification $\leftarrow s\mu\mu$ recon. eff.
 - hermeticity $\leftarrow \nu$ "reconstruction"

Solutions:

- ▶ Replace inner layers of the vertex detector with a pixel detector.
- ▶ Replace inner part of the central tracker with a silicon strip detector.
- ▶ Better particle identification device
- ▶ Replace part of endcap calorimeter crystals
- ▶ Faster readout electronics and computing system.

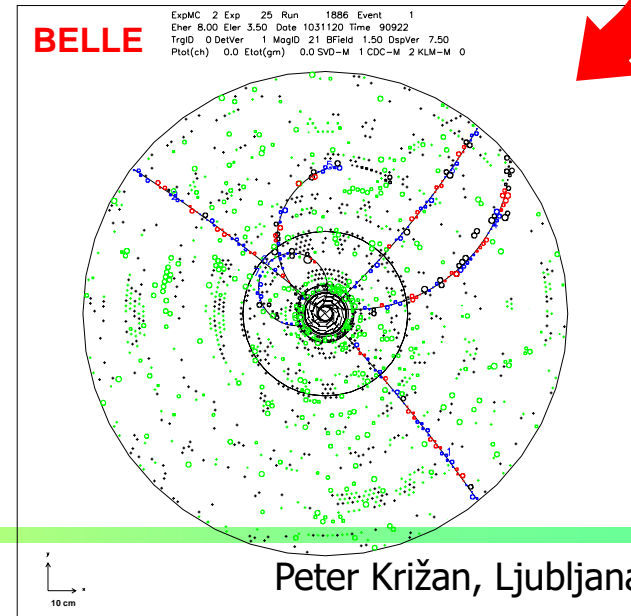
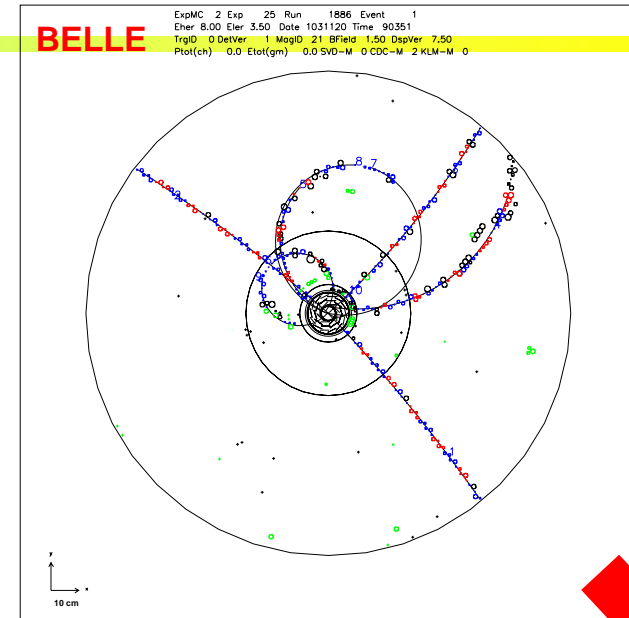

Belle II Detector

K_L and muon detector:
Resistive Plate Counter (barrel outer layers)
Scintillator + WLSF + MPPC (end-caps ,
inner 2 barrel layers)

EM Calorimeter:
CsI(Tl), waveform sampling

electrons (7GeV)

Particle Identification
Time-of-Propagation counter (barrel)
Prox. focusing Aerogel RICH (fwd)

Beryllium beam pipe
2cm diameter

Vertex Detector
2 layers DEPFET + 4 layers DSSD

positrons (4GeV)

Central Drift Chamber
He(50%):C₂H₆(50%), small cells, long
lever arm, fast electronics



Advanced & Innovative Technologies used in Belle II

Pixelated sensors play a central role



MCP-PMTs in the TOP
HAPDs in the ARICH
SiPMs in the KLM } photo-sensors

*Collaboration with
industry*

DEPFET pixel sensors (vertexing)

Essential: read-out with waveform sampling with precise timing

Front-end custom ASICs for most subsystems

DAQ with high performance network switches, large HLT software trigger farm

- KLM (*TARGETX* ASIC)
- ECL (New waveform sampling backend with good timing)
- TOP (*IRSX* ASIC)
- ARICH (KEK custom ASIC)
- CDC (KEK custom ASIC)
- SVD (APV25 readout chip adapted from CMS)
- PXD (3 Readout ASICs)

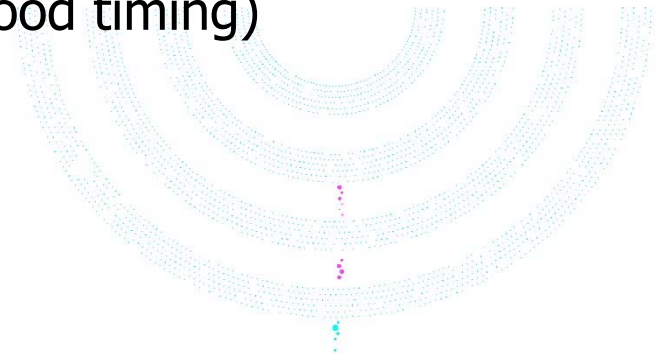

Vertexing/Inner Tracking

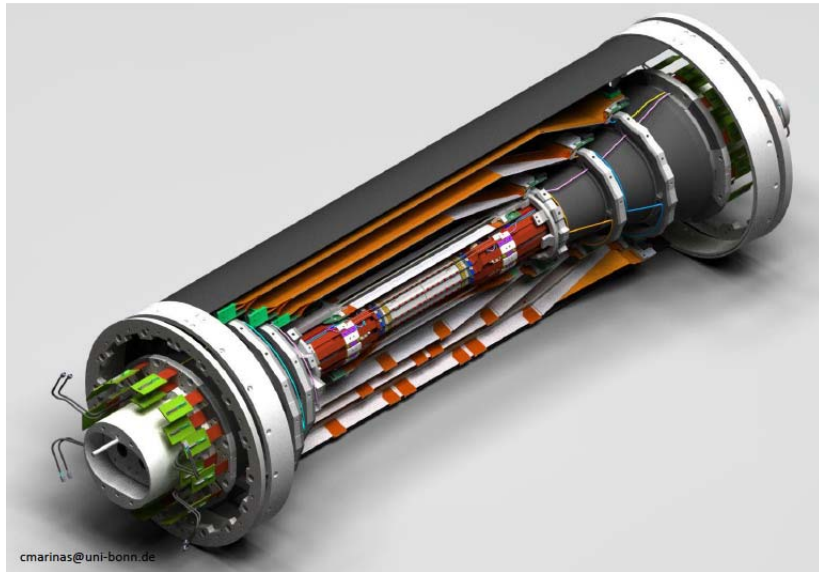

Beampipe $r=10$ mm (Japan)
DEPFET pixels (Germany, Czech Republic,
Spain, China, Poland)
Layer 1 $r=14$ mm
Layer 2 $r=22$ mm
DSSD (double sided silicon detectors)
Layer 3 $r=38$ mm (Australia)
Layer 4 $r=80$ mm (India)
Layer 5 $r=105$ mm (Austria)
Layer 6 $r=135$ mm (Japan)
FWD/BWD (Italy)
+Poland, Korea

Barrel Particle Identification (uses Cherenkov radiation)

The paths of Cherenkov photons from a 2 GeV pion and kaon interacting in a TOP quartz bar. (Japan, US, Slovenia, Italy)

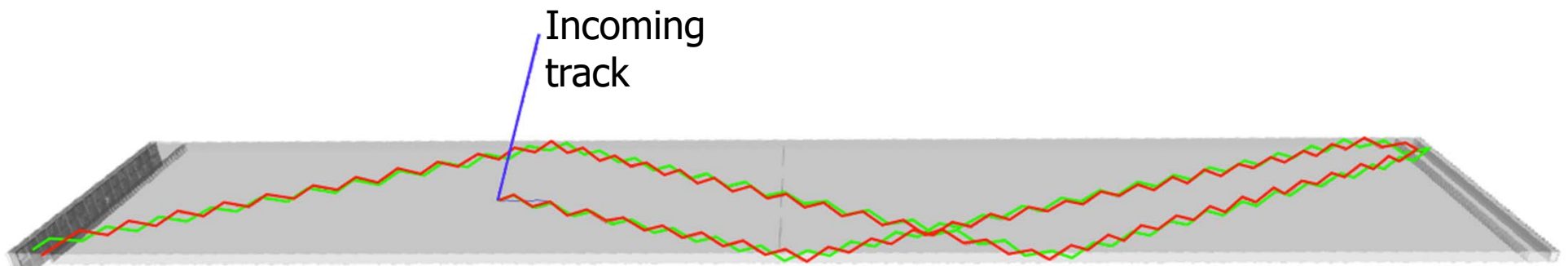



Particle Identification Devices

Barrel PID: Time of Propagation Counter (TOP)

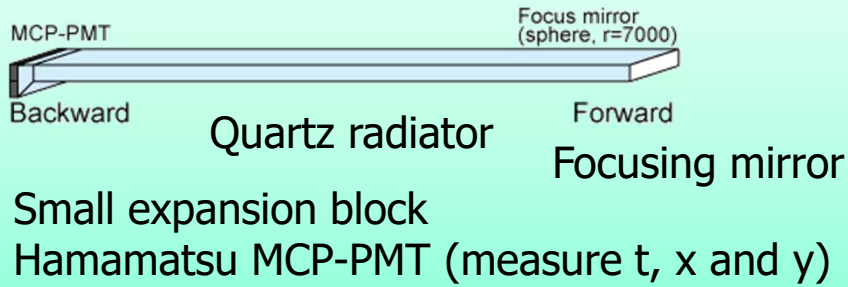

Endcap PID: Aerogel RICH (ARICH)

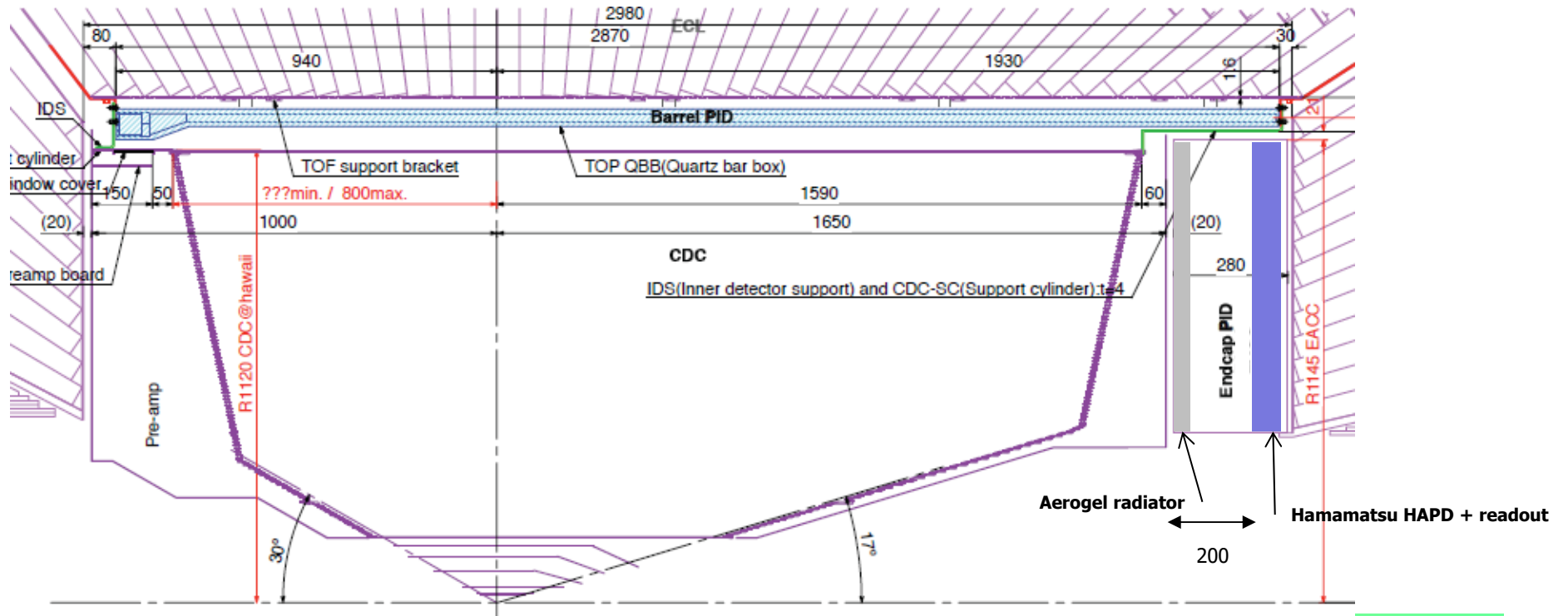
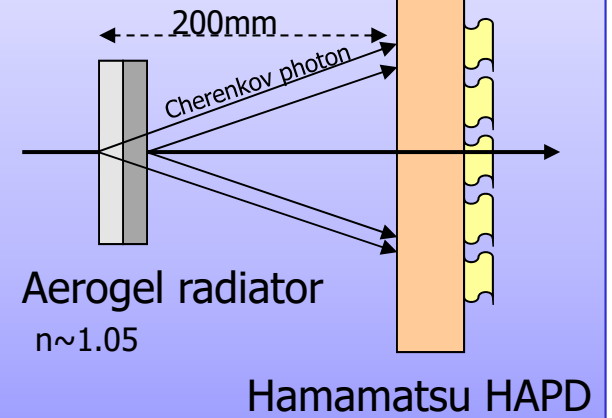

Peter Križan, Ljubljana

The big eye of ARICH

RICH with aerogel radiator in the forward region: How to increase the number of photons without degrading the resolution?

→ stack two tiles with different refractive indices: “focusing” configuration

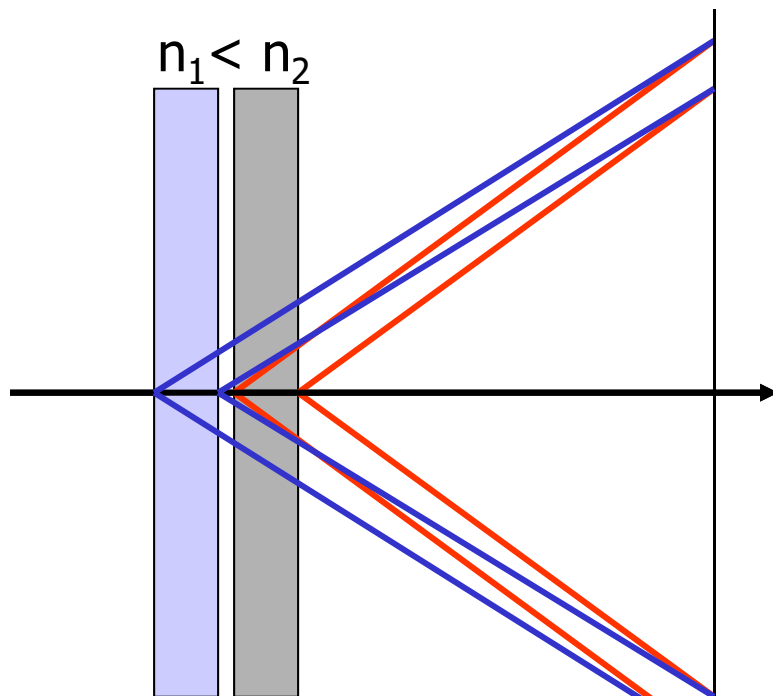

→ focusing radiator

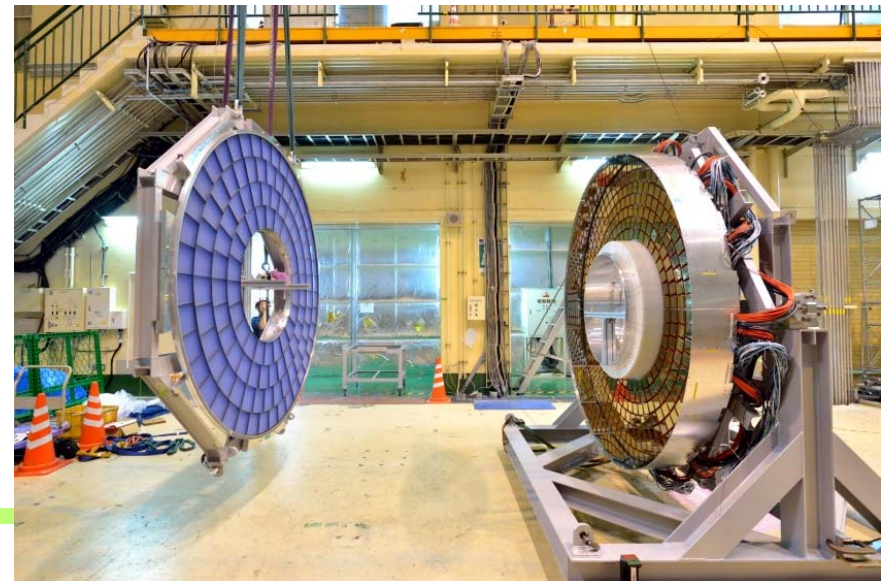
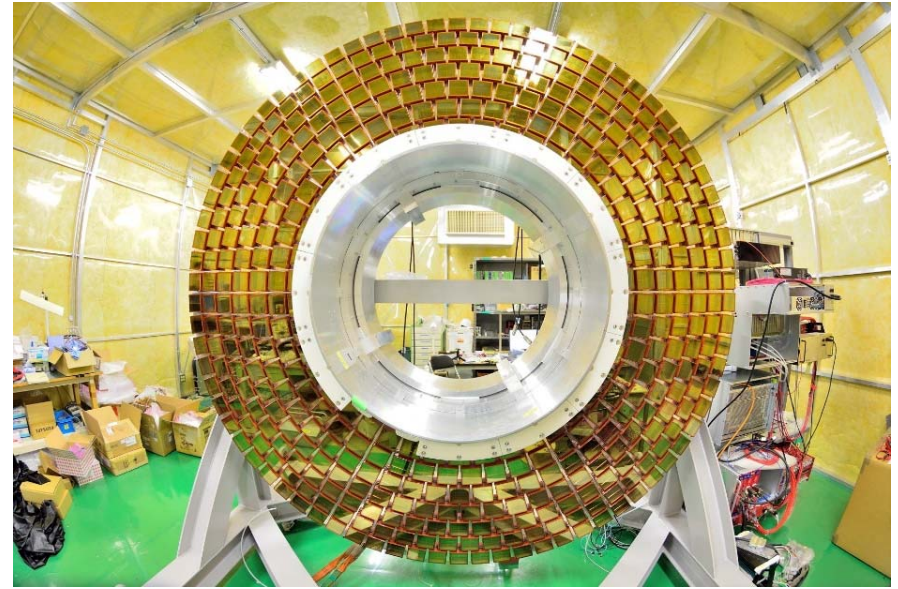

Barrel PID: Time of propagation (TOP) counter

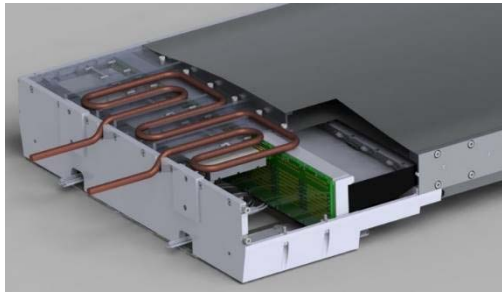

Photon detector

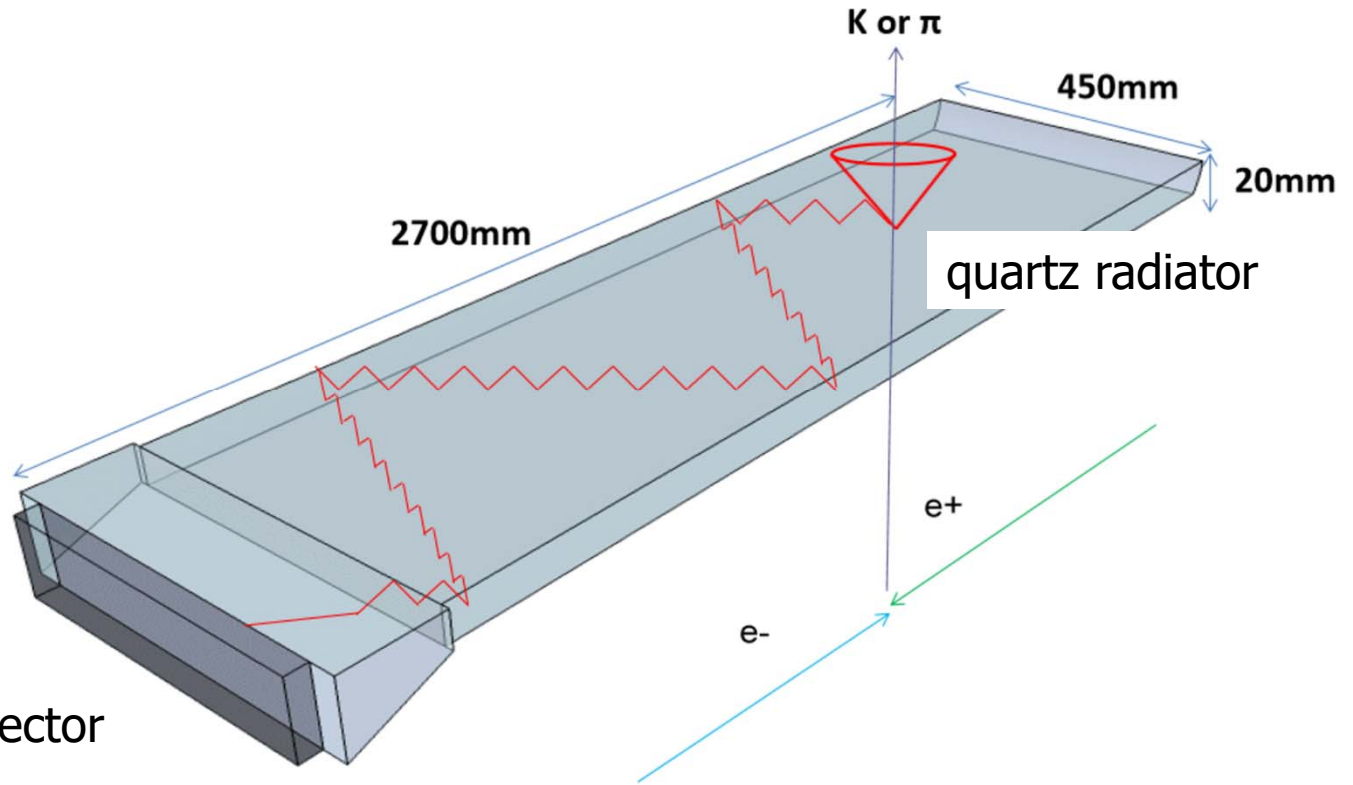

- Cherenkov ring imaging with precise time measurement.
- Reconstruct Cherenkov angle from two hit coordinates and the time of propagation of the photon
 - Quartz radiator (2cm thick)
 - Photon detector (MCP-PMT)
 - Excellent time resolution ~ 40 ps
 - Single photon sensitivity in 1.5 T

Belle II Roll-in

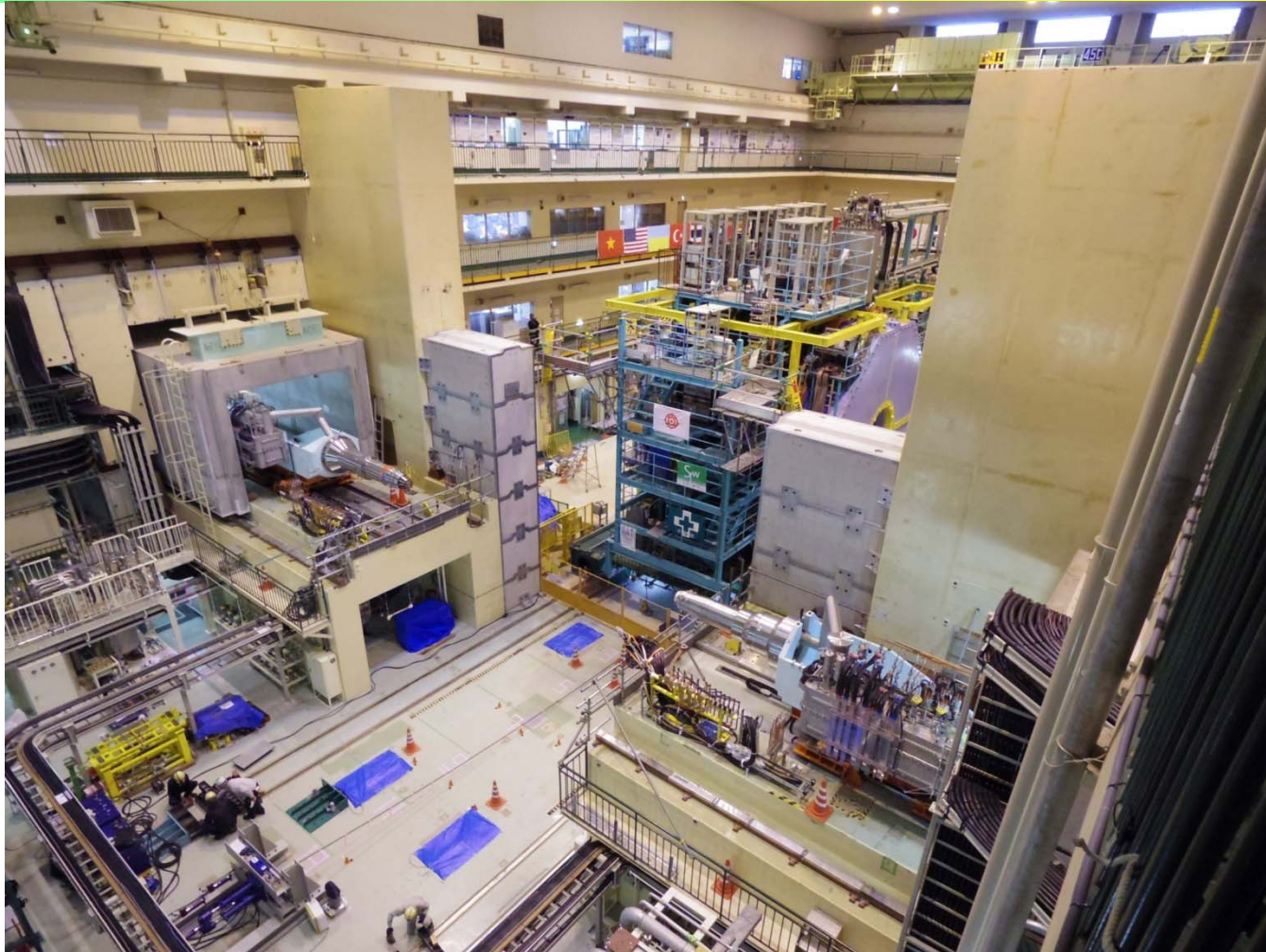

Belle II rolled-in to the beam line on April 11th, 2017
One of the most significant milestones in the construction phase

Peter Križan, Ljubljana

Belle II Roll-in



Belle II rolled-in to the beam line on April 11th, 2017
One of the most significant milestones in the construction phase

Peter Križan, Ljubljana

Belle II Roll-in

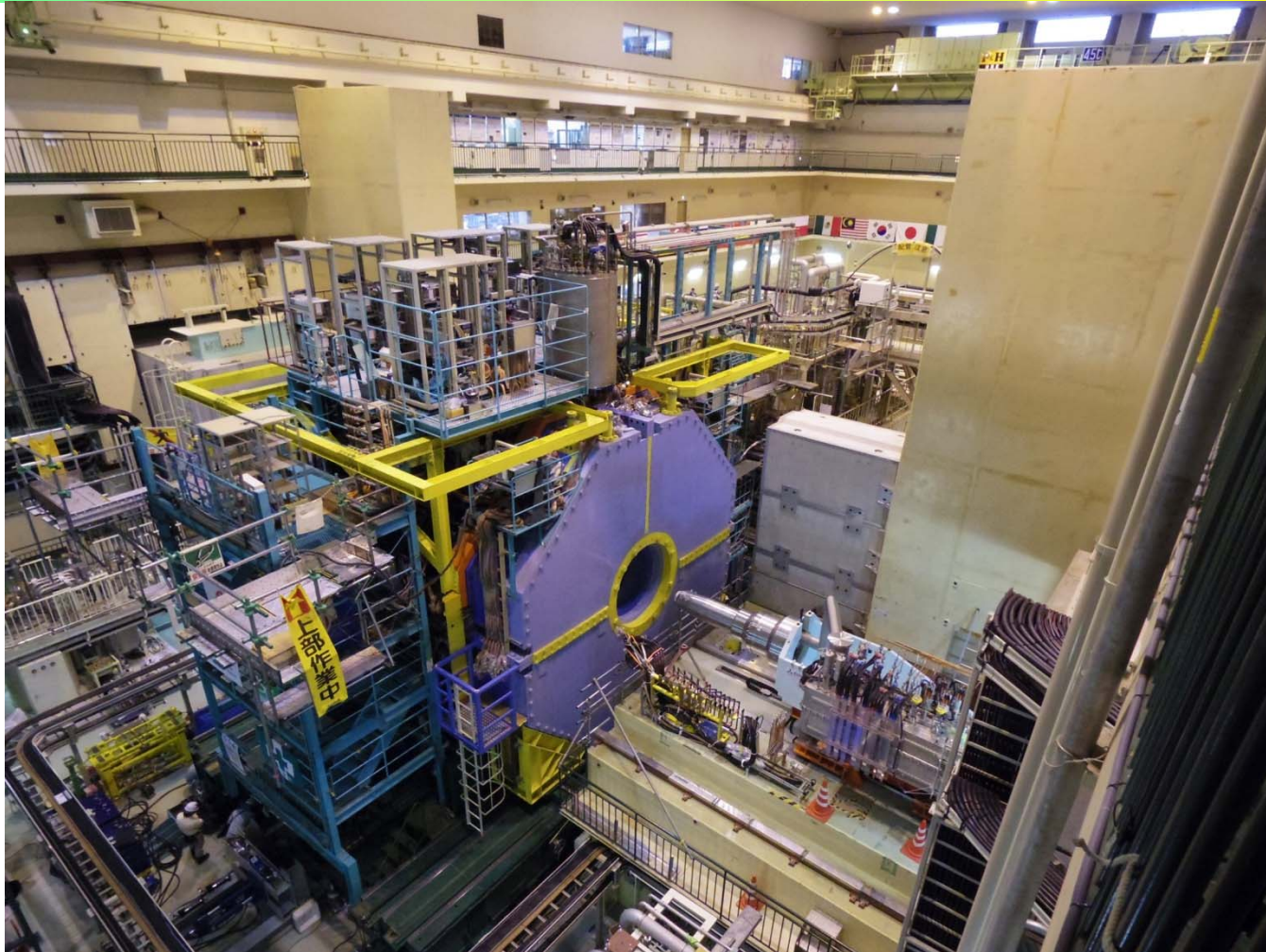

Belle II rolled-in to the beam line on April 11th, 2017
One of the most significant milestones in the construction phase

Peter Križan, Ljubljana

Belle II / SuperKEKB Operation phases

Phase 1:

Background, Vacuum Scrubbing, RF system
Feb-June 2016.

Brand new 3 km positron ring.

Phase 2: Pilot run without VXD

Superconducting Final Focus, add positron damping ring,
First Collisions on Apr. 26, 2018 (0.5 fb^{-1}).

Feb-July, 2018

Phase 3: → Physics running (spring 2019, fall 2019, spring 2020).

Have integrated 74 fb^{-1} so far.

Belle II Integrated Luminosity

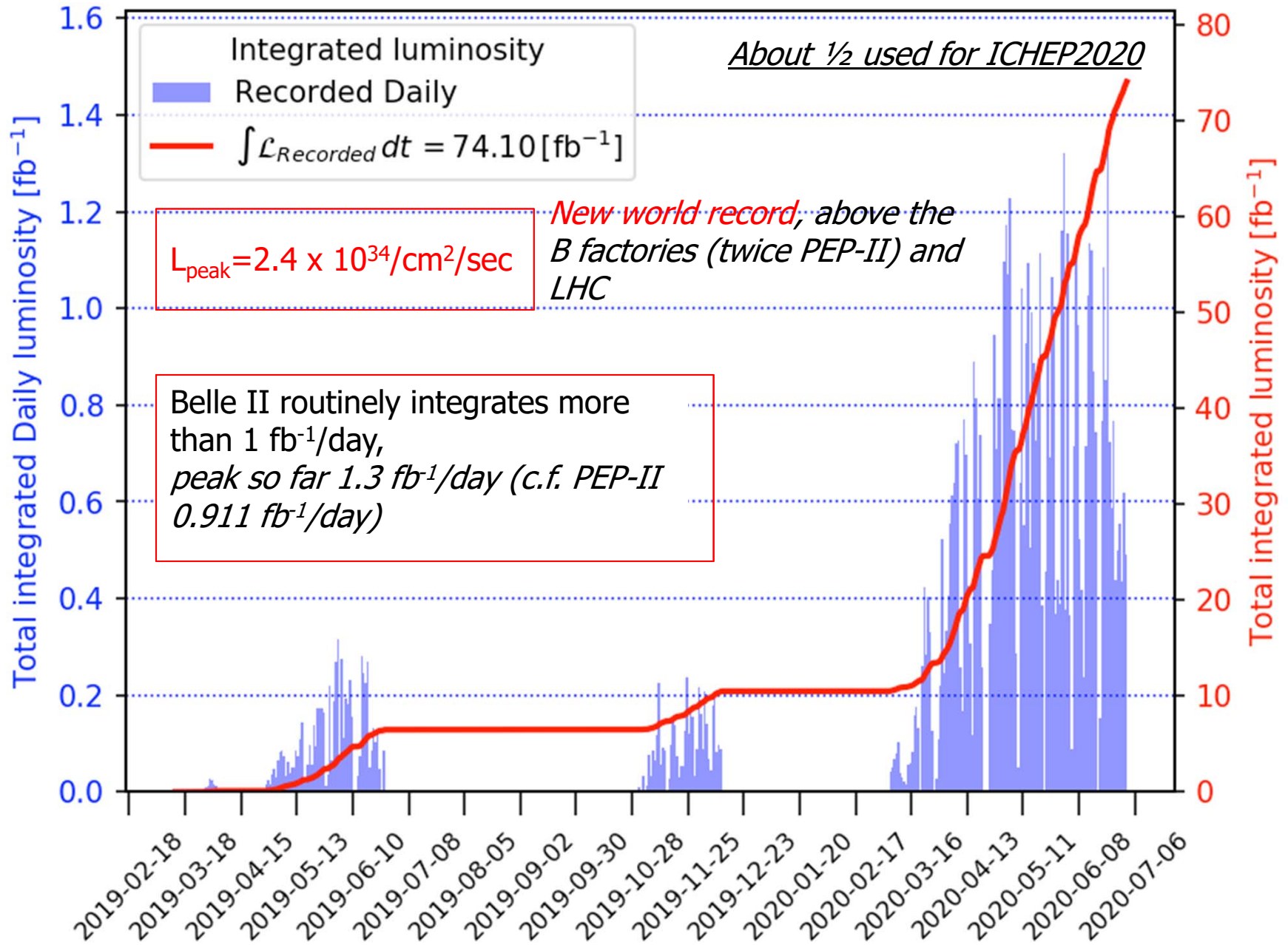

Also see <https://cerncourier.com/a/kek-reclaims-luminosity-record/>

Major issue in the operation: fighting the backgrounds

Detector lifetime (in particular TOP counter)

- To keep the MCP-PMT QE within an acceptable level until 50 ab^{-1} , the Touschek and beam-gas backgrounds have to be kept constant by collimators, beam tuning, additional shielding, ...
→ TOP PMT hit rate could limit the luminosity.

Permanent damage on PXD and SVD by accidental huge beam loss.

Synchrotron radiation from HER beam on PXD

- Should be carefully monitored not to irradiate PXD unnecessarily.

Spring 2020: Running an international experiment and accelerator during a global pandemic

SuperKEKB/Belle II was/is operating during the COVID-19 pandemic with protocols in place to maximize safety and minimize the risk of infection. Somewhat difficult with travel restrictions and a heavy load on a skeleton crew at KEK (~40 people).

Developed a "social distancing" scheme for on-site shifts in the Belle II and SuperKEKB control rooms. Mobilized remote shifters around the world – depended heavily on internet chat utilities for communication and monitoring.

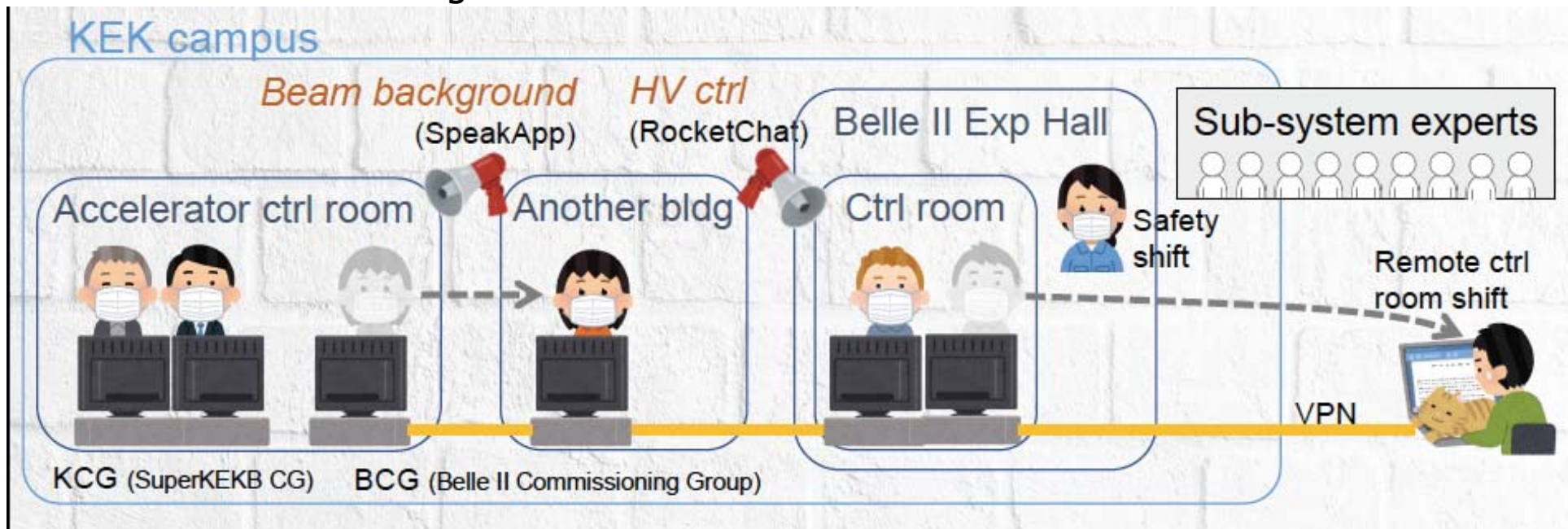
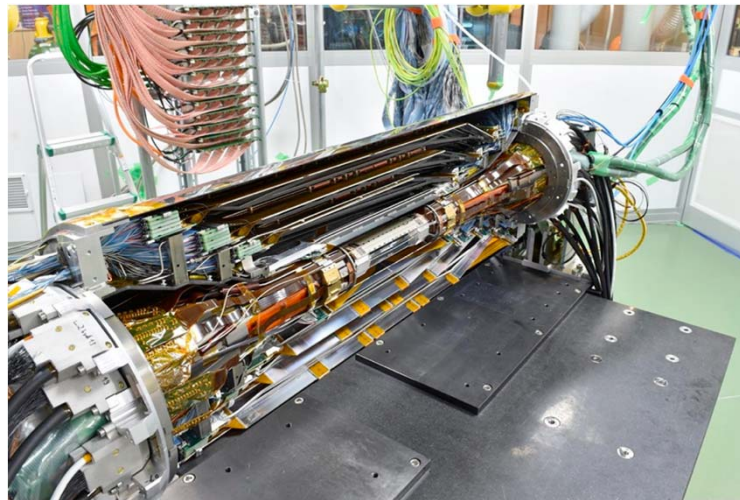

Figure credit: K. Matsuoka



Belle II/SuperKEKB Phase 3 (Physics Run) Goals

Early aims: Demonstrate SuperKEKB Physics running with acceptable backgrounds, and all the detector, readout, DAQ and trigger capabilities of Belle II including tracking, electron/muon id, high momentum PID, and especially the *ability to do **time-dependent measurements** needed for CP violation.*



Carry out innovative and world leading dark sector searches/measurements. Publish first papers.

Long term: *Integrate the world's largest e^+e^- data samples and observe or constrain New Physics in B physics, charm physics and tau physics.*

Dark Sector:

B factories: limited by triggering, QED backgrounds and theoretical imagination. *Now new possibilities of triggering, more bandwidth.*

There are a variety of possible dark sector portal particles:
Vector, Scalar, Pseudo-scalars.

They may decay to lepton pairs, photon pairs, or **Invisible particles**

Belle II First Physics. A novel result on the dark sector ($Z' \rightarrow \text{nothing}$) recoiling against di-muons *or* an electron-muon pair. *Both possibilities are poorly constrained at low Z' mass and in the first case, could explain the muon $g-2$ anomaly.*

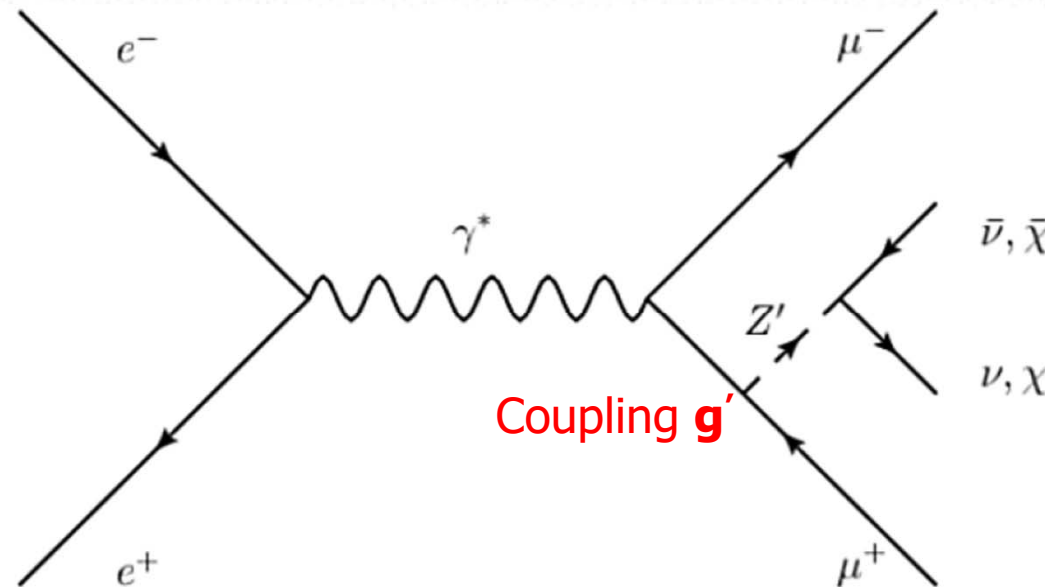

Also examine a *lepton flavor violating* NP signature in the dark sector

Monte Carlo simulation of a $Z' \rightarrow$ invisible

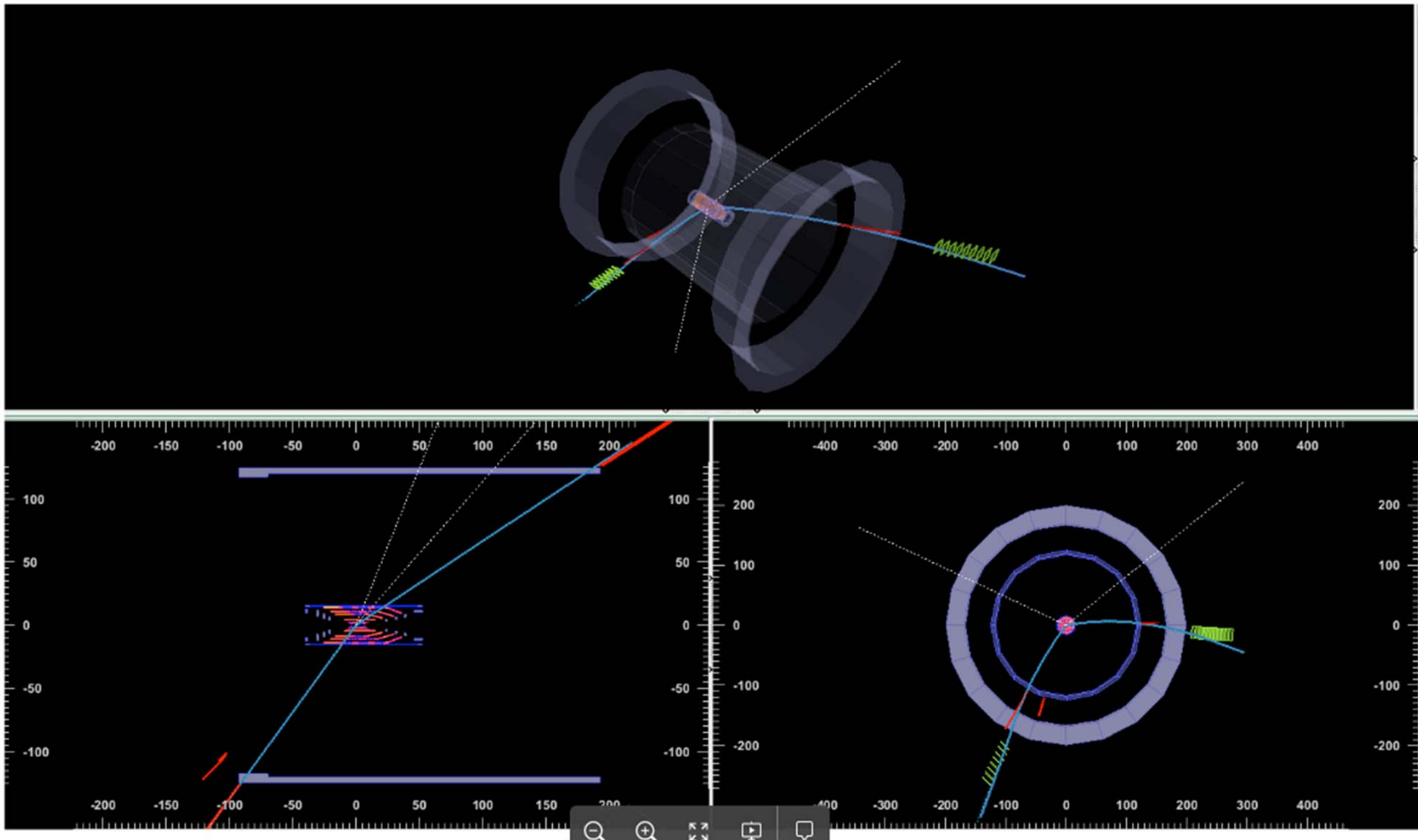

However, in data we do not find any significant excess in the recoil mass distribution.



With 278 pb⁻¹ from the Phase 2 pilot run

Phys.Rev.Lett. 124 (2020) 14

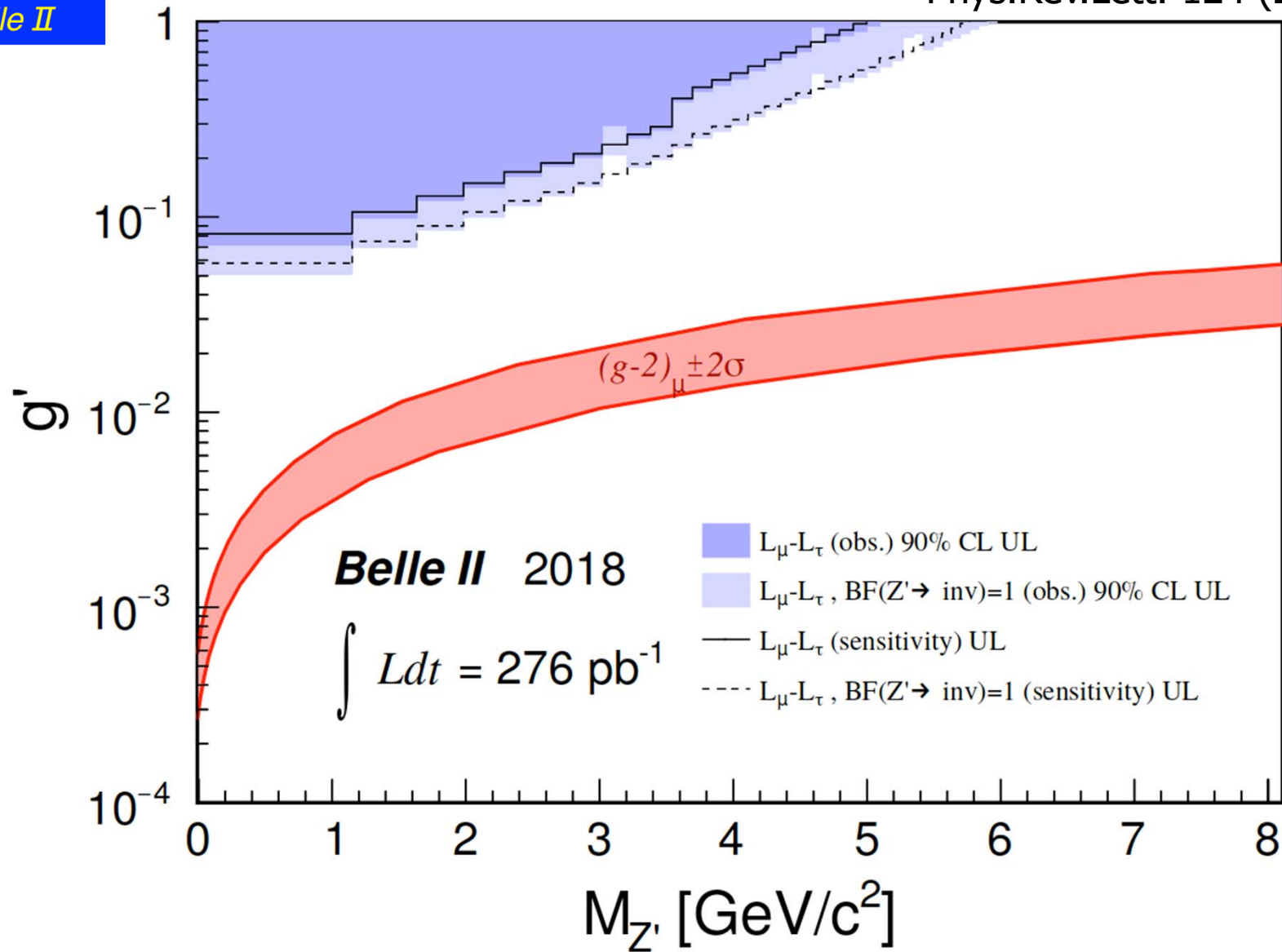



Near term prospects for $Z' \rightarrow \text{invisible}$

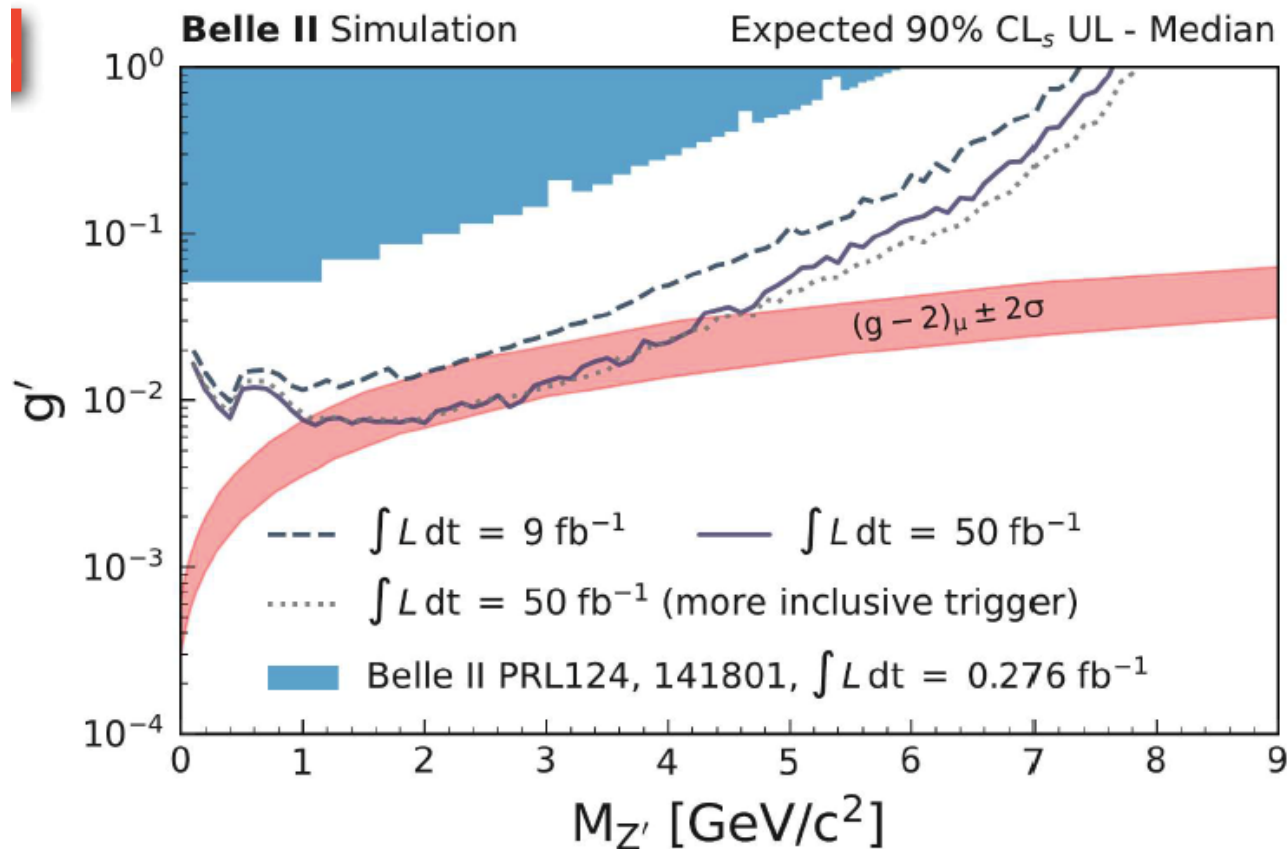
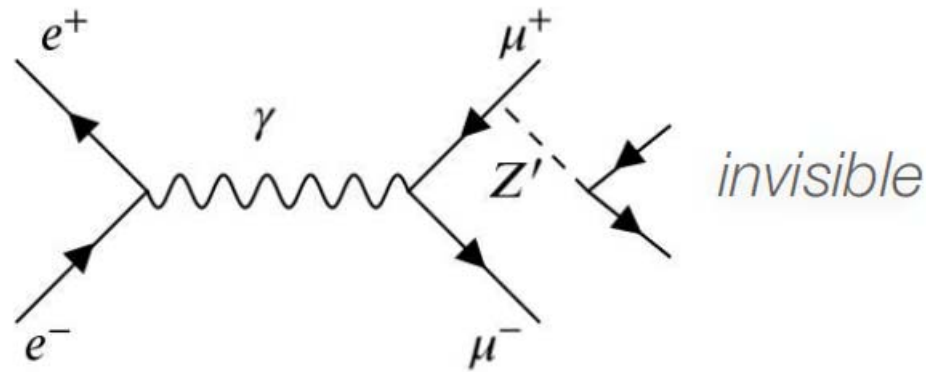

Uses Phase 3 data on tape. Adding in KLM triggers may allow us to “break through” the $g-2$ band.

Search for ALPs (Axion Like Particles) at Belle II

An extra term was introduced in the QCD Lagrangian by Peccei, Quinn to solve the strong CP problem in 1977. Wilczek introduced a particle interpretation called the Axion. Expected to be very light (microeV or millieV).

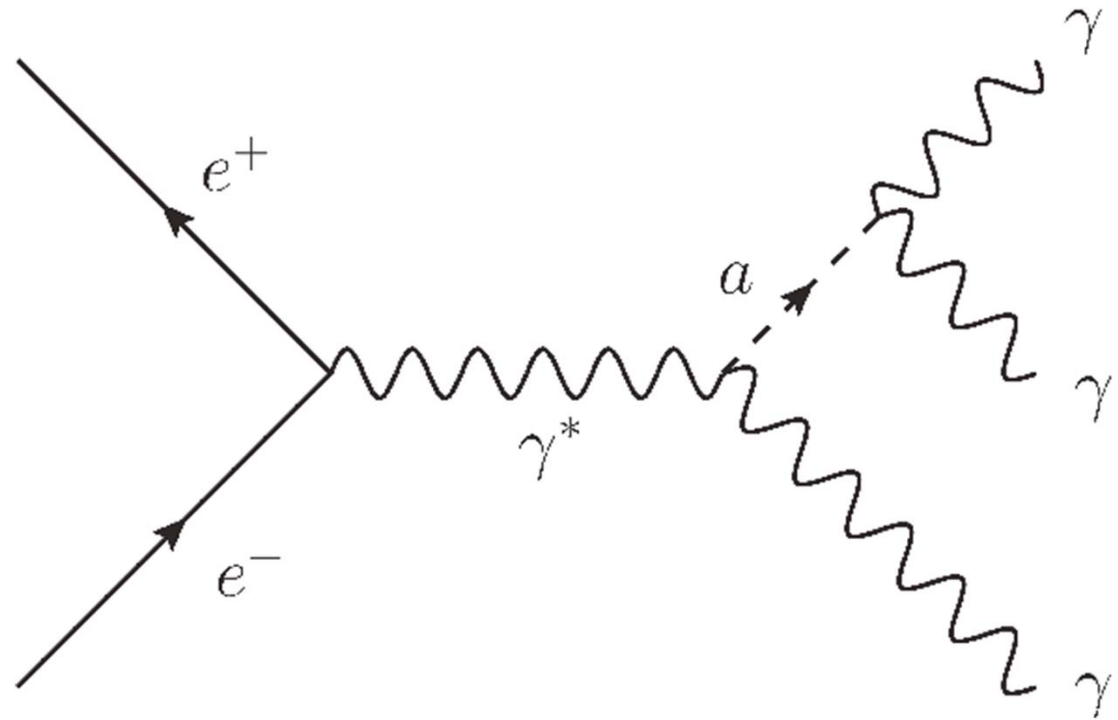

Examine the three photon final state:

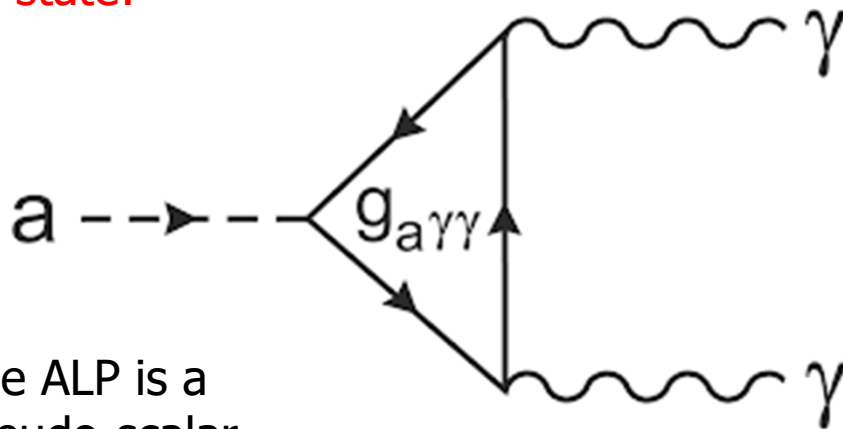

The ALP is a pseudo-scalar





The Belle II mass range is 200 MeV to 9.7 GeV, far above the keV mass range suggested by the Xenon1T excess.

<https://arxiv.org/abs/2006.09721>

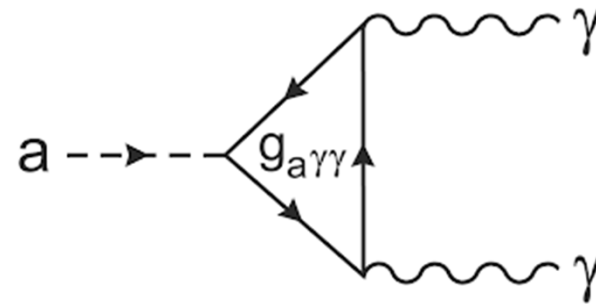

Final ALPS results with 445 pb⁻¹ of pilot run (Phase 2) data

arxiv:2007.13071

Plan to update with two orders of magnitude more data.

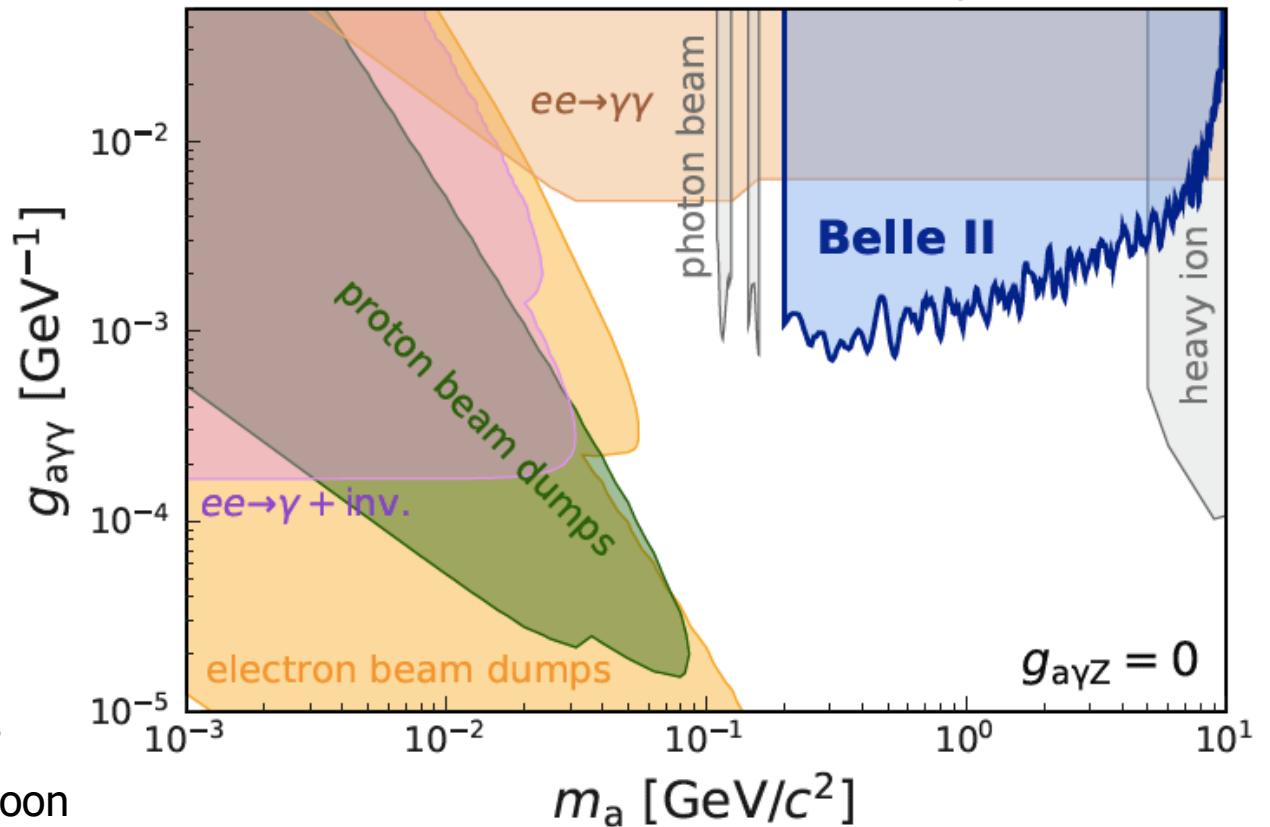

* Missing in this plot: a recast of LEP results, plot to be updated soon

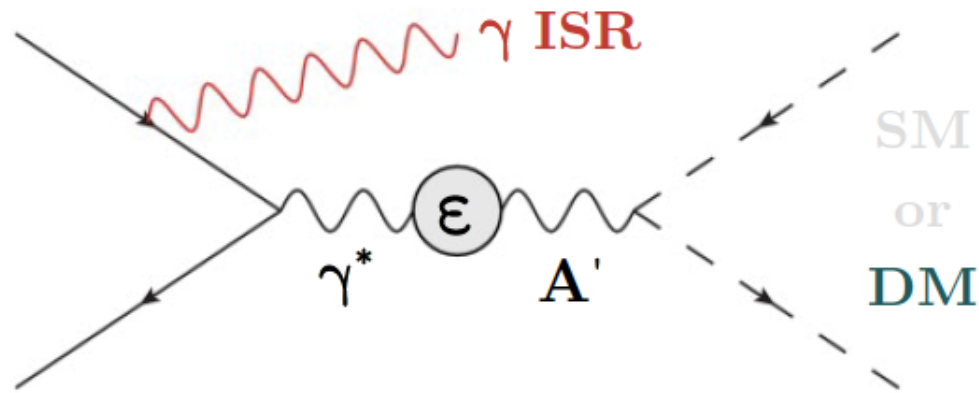

Sensitivity for the “dark photon” with the signature: $e^+e^- \rightarrow \gamma + \text{nothing}$

- a bump in the recoil mass:

$$E_\gamma = \frac{s - m_{A'}^2}{2\sqrt{s}}$$

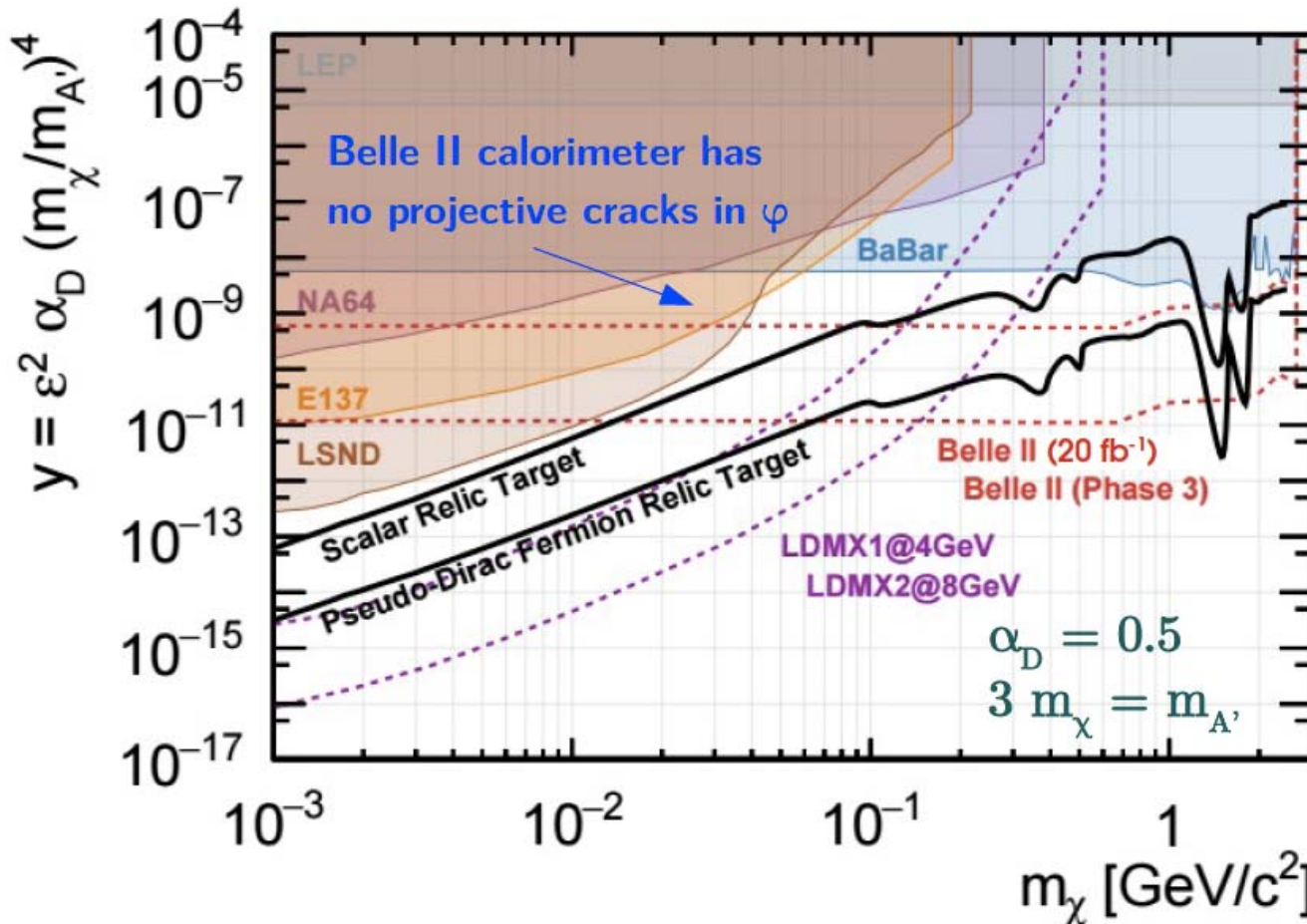

Lower trigger threshold wrt BaBar

J. Alexander et al. (2016), *arXiv:1608.08632*
 N. Toro, private communication (2017)
 J. P. Lees et al., BaBar (2017), *arXiv:1702.0332*
 The Belle II Physics Book, *arXiv:1808.10567*

Flavor Results from the Physics Run ("Phase 3")

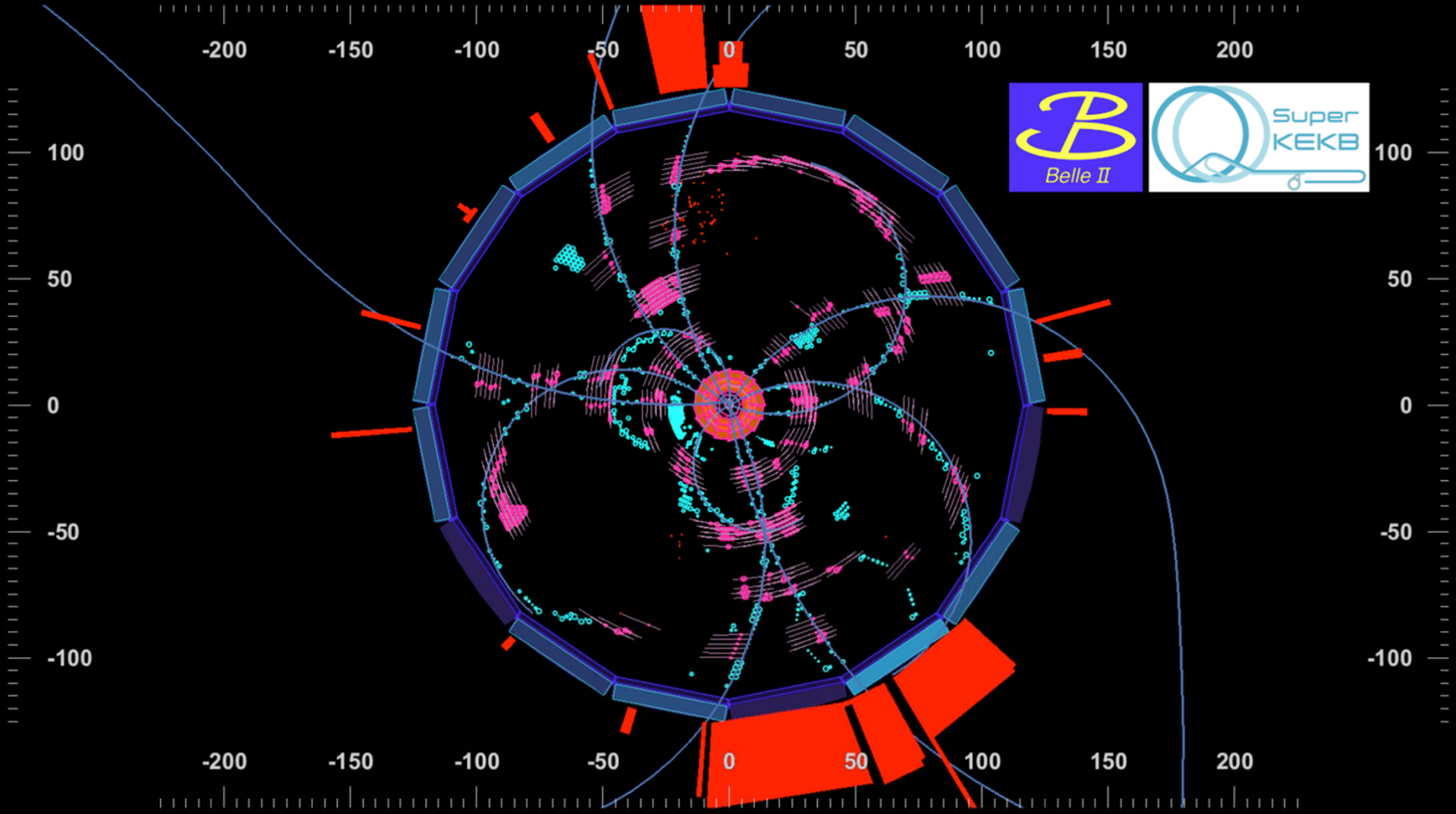

Time Dependent Measurements at Belle II



Belle II VXD installed on Nov 21, 2018.

- PXD: L1 and two ladders of L2,
- SVD (4 layers)

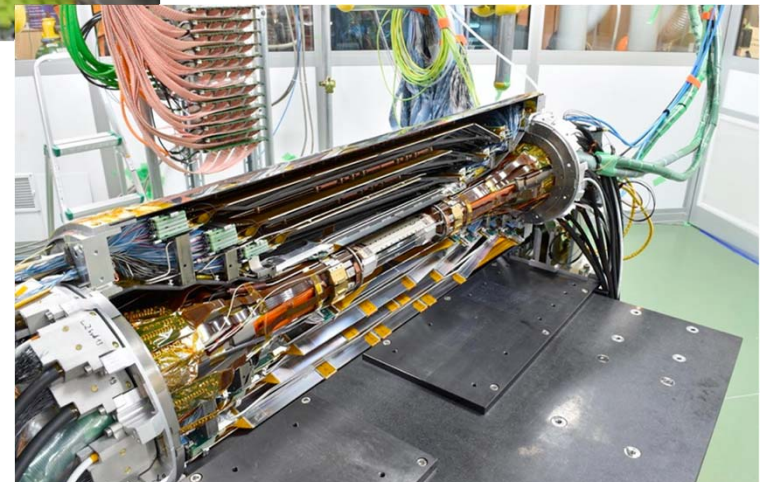

Check time-dependent capabilities: Examples of D^0 lifetime results.

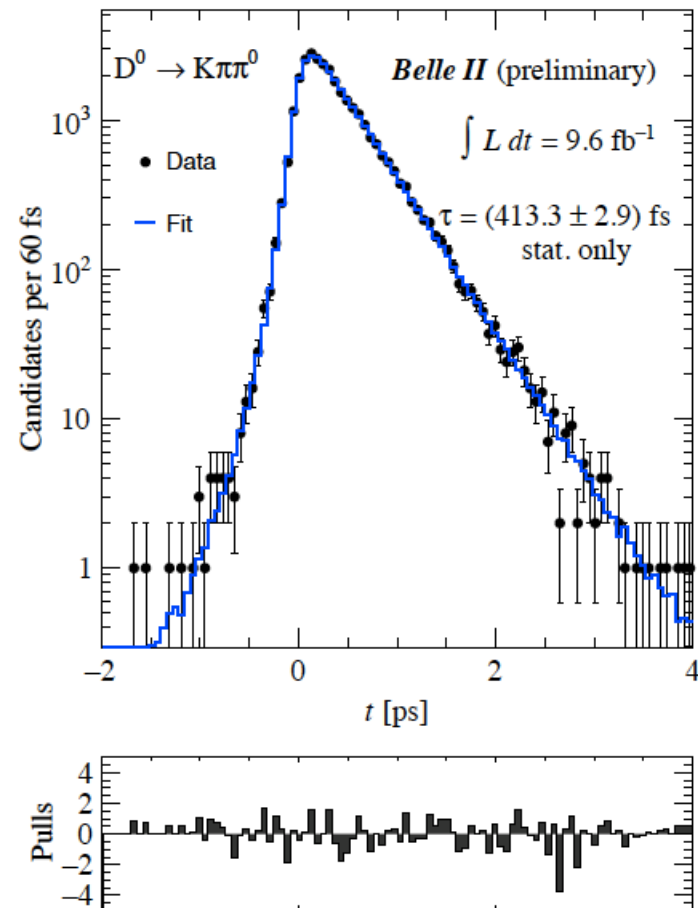
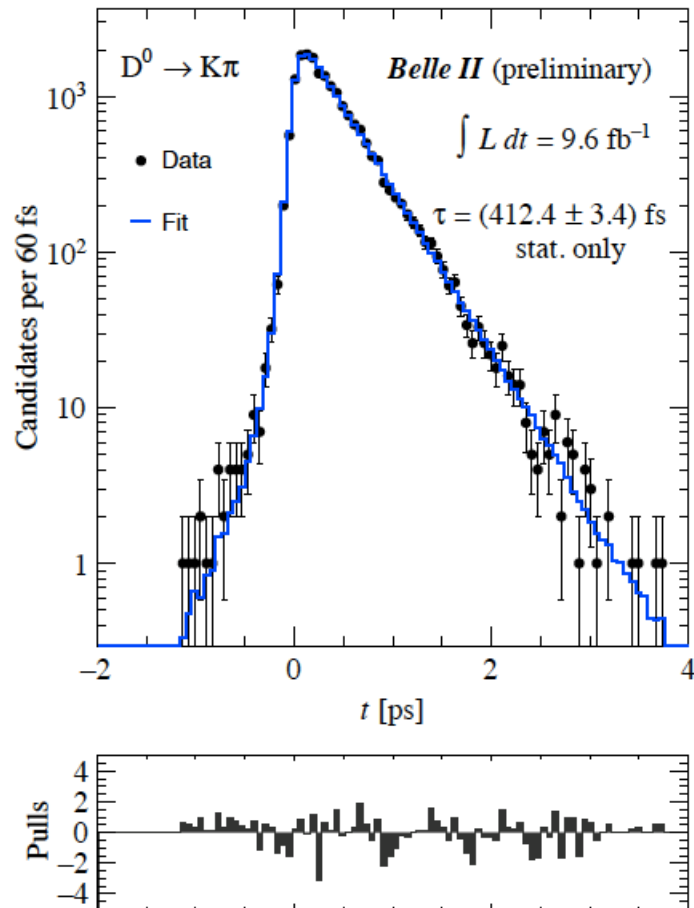

Time resolution parameterization can be determined from data.

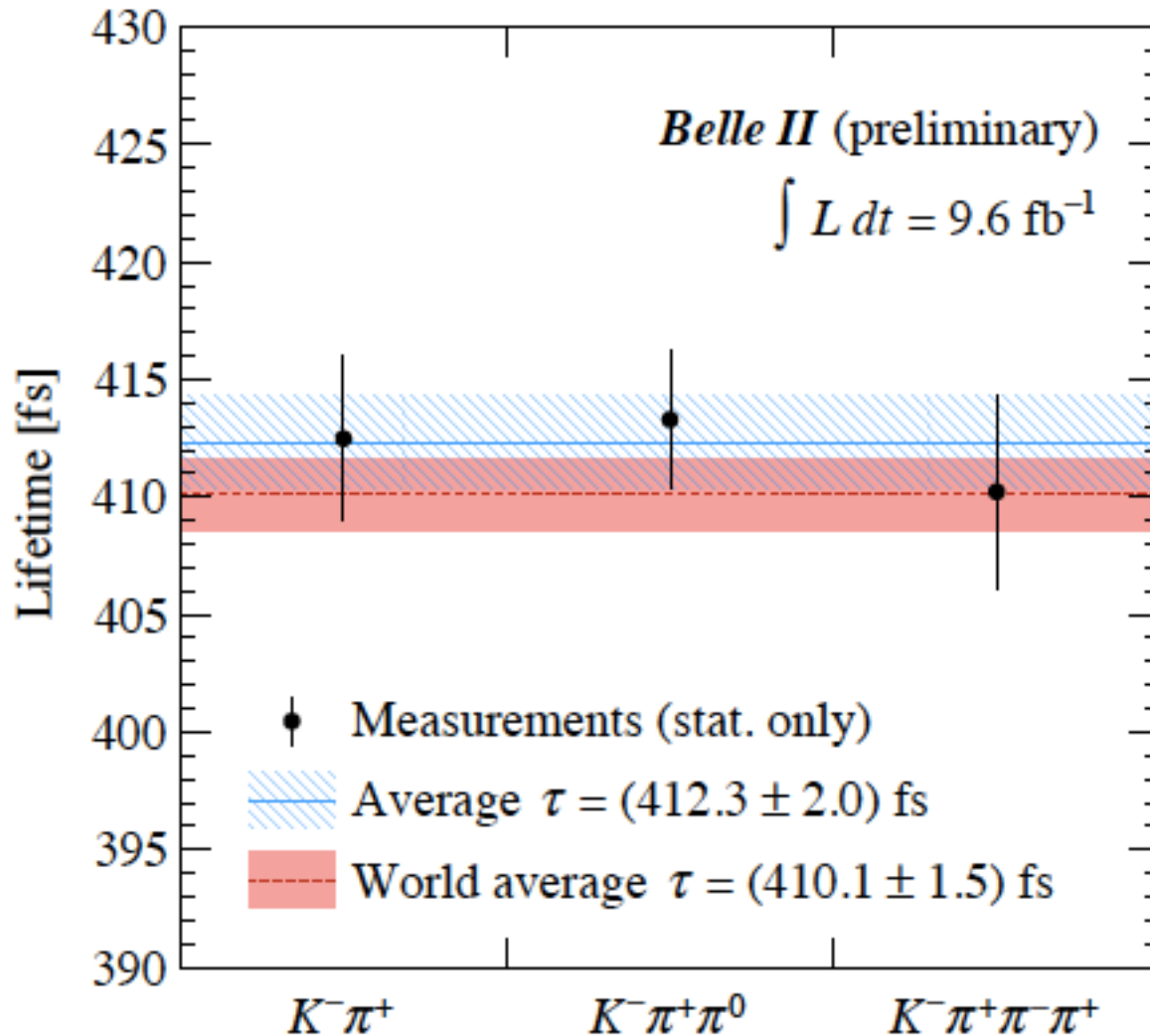

The addition of a pixel vertex detector (with a 1cm radius beampipe) gives a *factor of two improvement* in proper time resolution for charm lifetime measurements compared to Belle. Alignment systematics are much improved.

B^0 Lifetime measurement ($B \rightarrow D^{(*)} h$)

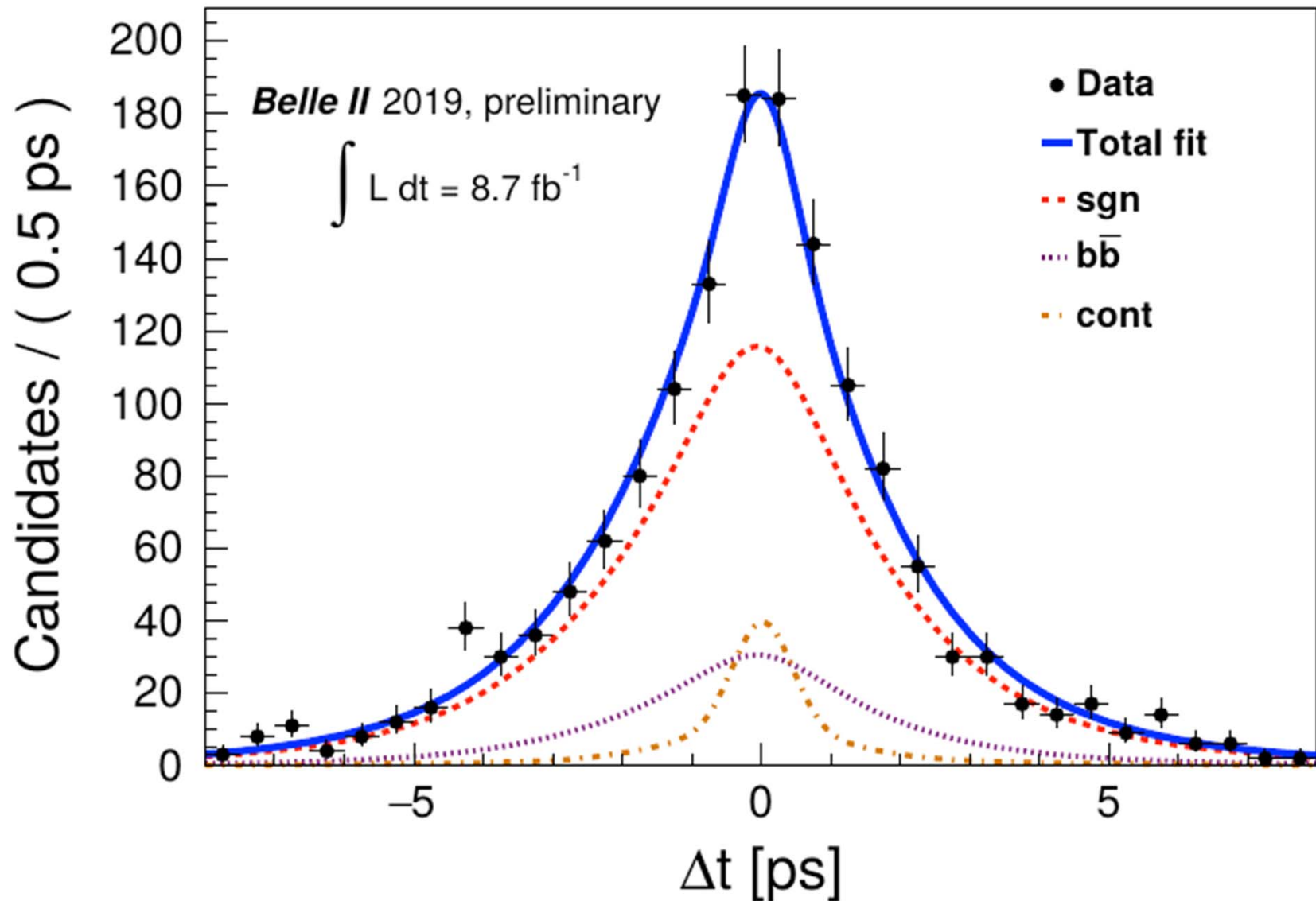

$$\tau(B^0) = 1.48 \pm 0.28 \pm 0.06 \text{ ps}$$

<https://arxiv.org/pdf/2005.07507>

Flavor Tagging (b quark or anti-b quark ?)

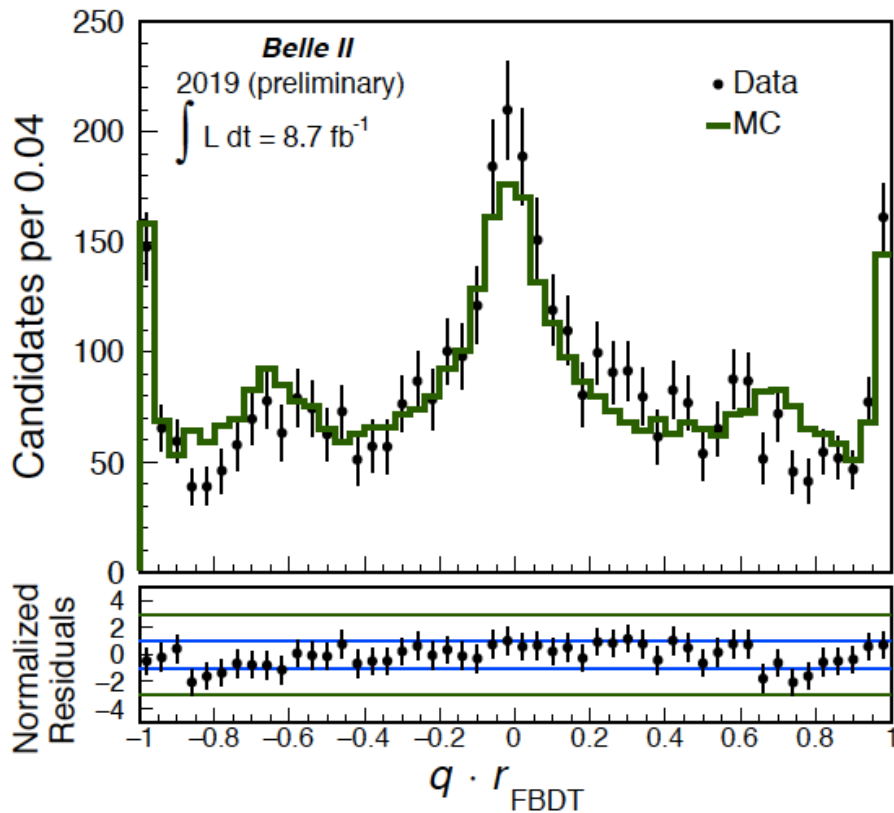

| Categories | Targets for \bar{B}^0 | Underlying decay modes |
|-----------------------------|-------------------------|--|
| Electron | e^- | $\bar{B}^0 \rightarrow D^{*+} \bar{\nu}_\ell \ell^-$ |
| Intermediate Electron | e^+ | $\hookrightarrow D^0 \pi^+$ |
| Muon | μ^- | $\hookrightarrow X K^-$ |
| Intermediate Muon | μ^+ | |
| Kinetic Lepton | l^- | $\bar{B}^0 \rightarrow D^+ \pi^- (K^-)$ |
| Intermediate Kinetic Lepton | l^+ | $\hookrightarrow K^0 \nu_\ell \ell^+$ |
| Kaon | K^- | |
| Kaon-Pion | K^-, π^+ | |
| Slow Pion | π^+ | |
| Maximum P* | l^-, π^- | $\bar{B}^0 \rightarrow \Lambda_c^+ X^-$ |
| Fast-Slow-Correlated (FSC) | l^-, π^+ | $\hookrightarrow \Lambda \pi^+$ |
| Fast Hadron | π^-, K^- | $\hookrightarrow p \pi^-$ |
| Lambda | Λ | |

We obtain $\epsilon_{\text{eff}} = \epsilon(1-2w^2) = \mathbf{33.8 \pm 3.9\%}$, which is a slight improvement over the Belle result of $30.1 \pm 0.4\%$

Agreement of Data and MC



Hint of time-dependent CPV from Belle II (2.7σ significance)

BELLE2-NOTE-PL-2020-011

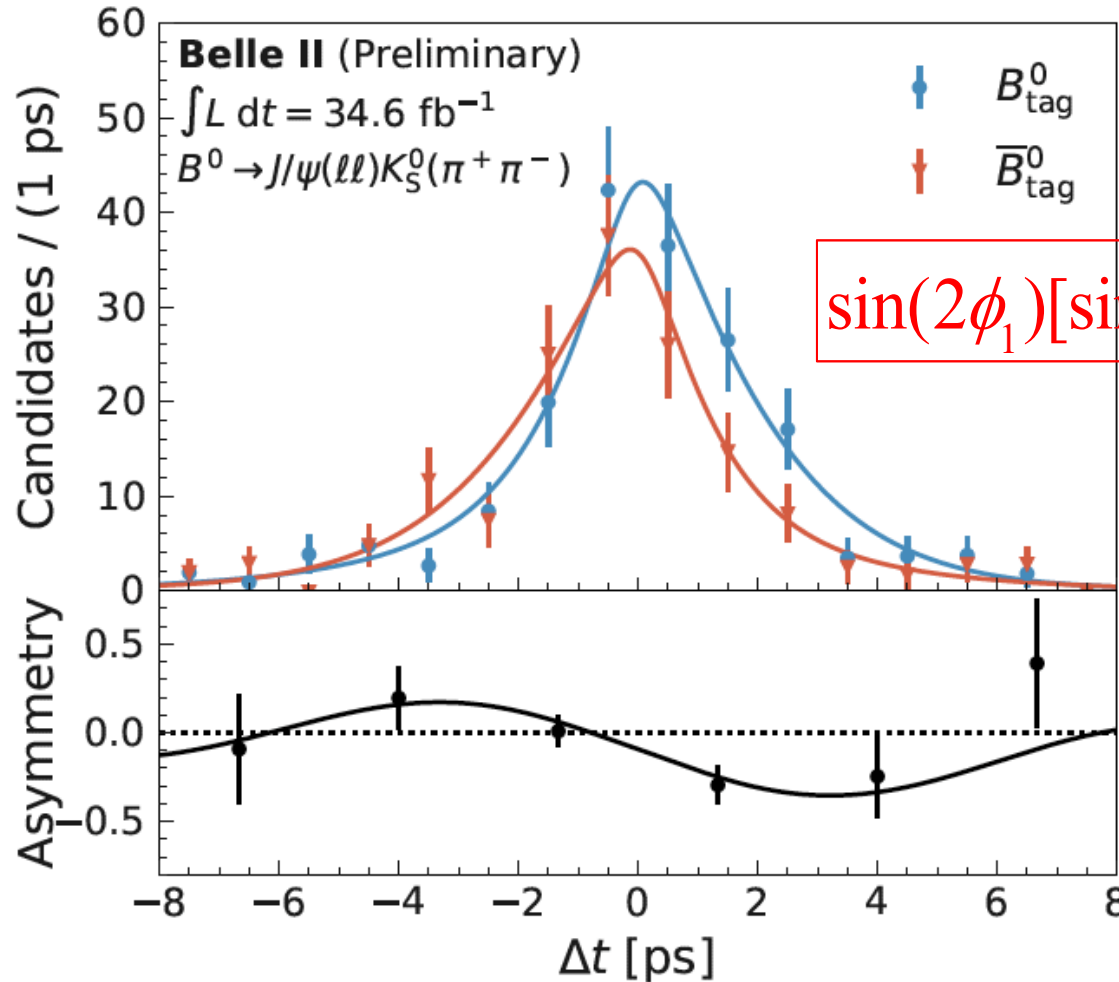

$$\sin(2\phi_1)[\sin(2\beta)] = 0.55 \pm 0.21 \pm 0.04$$

(WA=0.691±0.017)

$$B^0 \rightarrow f ; \overline{B^0} \rightarrow f$$

$$N_{+/-} = \frac{\exp(-|\Delta t|/\tau)}{4\tau} \left\{ 1 \pm (1-2w) \sin(2\phi_1) \sin(\Delta m_d \Delta t) \right\} \otimes R(\Delta t)$$

Full Event Interpretation (FEI)

Idea: **reconstruct** one of the B's to tag B flavor/charge, determine its momentum, and exclude decay products of this B from further analysis
(exactly two B's produced in $\Upsilon(4S)$ decays)

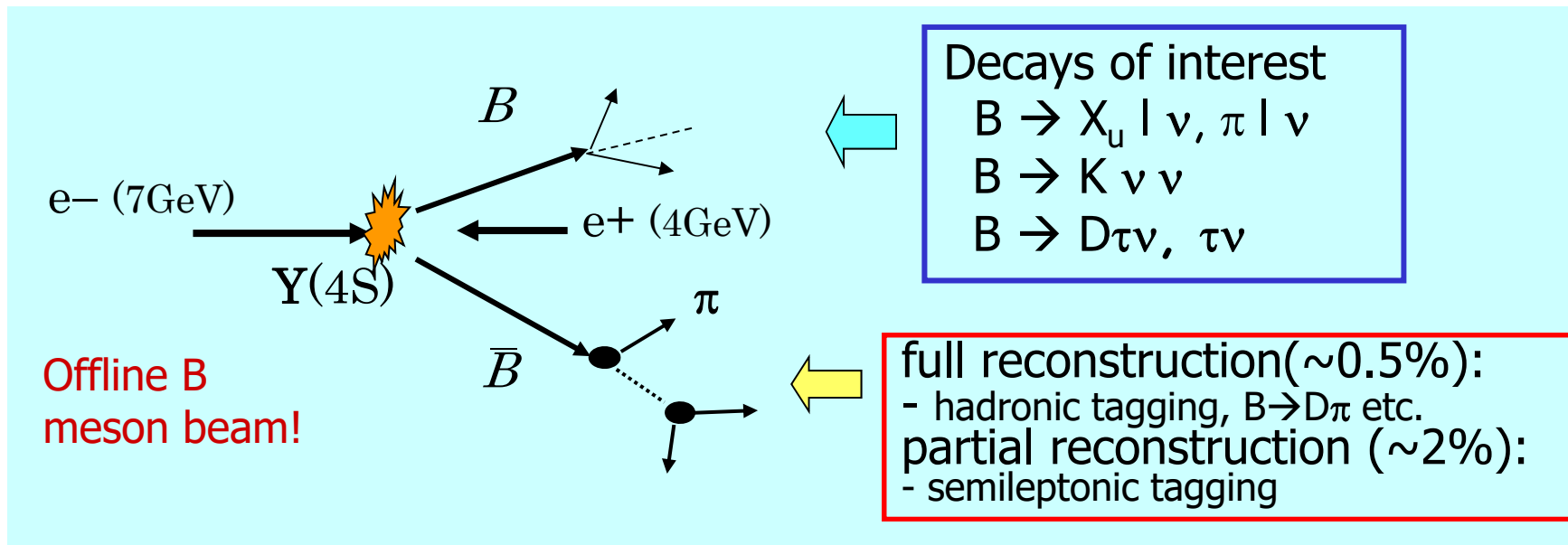

Powerful tool for B decays with neutrinos

→ unique feature at B factories



V_{ub} : Exclusive $B \rightarrow \pi l^+ \nu$ with FEI

Measurements of the BF at $q^2(\text{max})$ combined with lattice QCD gives $|V_{ub}|$

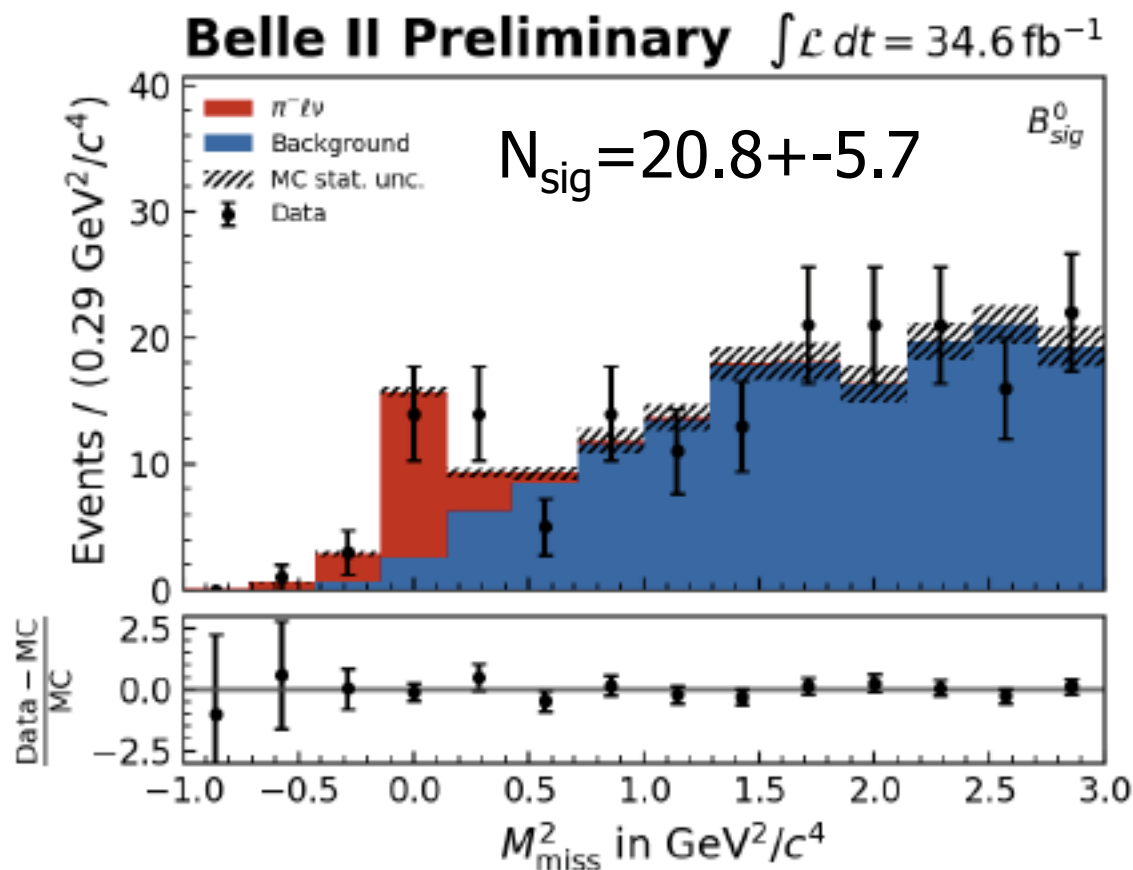

FIG. 4: Post-fit M_{miss}^2 distribution in 34.6 fb^{-1} of data.

$$BF(B^0 \rightarrow \pi^- l^+ \nu) = [1.58 \pm 0.43(\text{stat}) \pm 0.07(\text{sys})] \times 10^{-4}$$

Tau Mass Measurement

Use 1 prong vs 3-prong tau pair events from $e^+e^- \rightarrow \tau^+ \tau^-$

$$M_{\min} = \sqrt{M_{3\pi}^2 + 2(E_{\text{beam}} - E_{3\pi})(E_{3\pi} - P_{3\pi})} \leq m_{\tau}$$

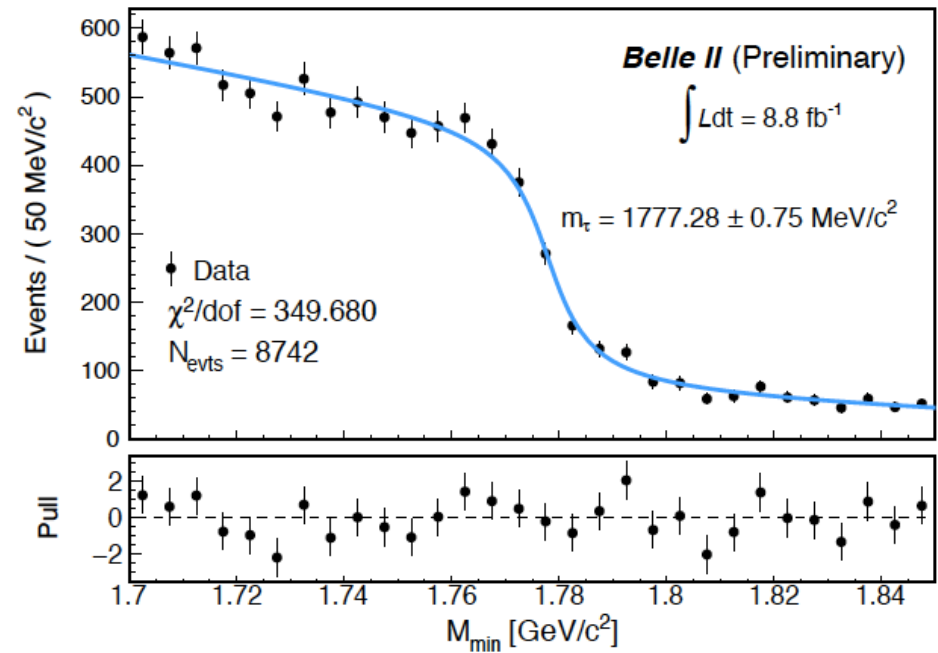

$$m(\tau) = 1777.28 \pm 0.75(\text{stat}) \pm 0.33(\text{sys}) \text{ MeV}/c^2$$

arXiv:2008.04665 [hep-ex]

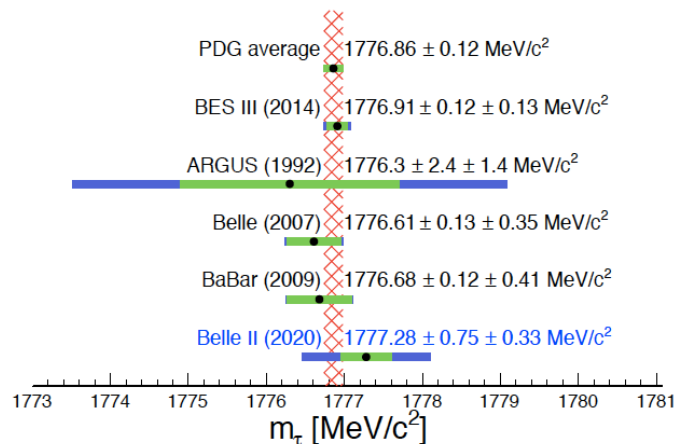

Currently BESIII dominates the world average.

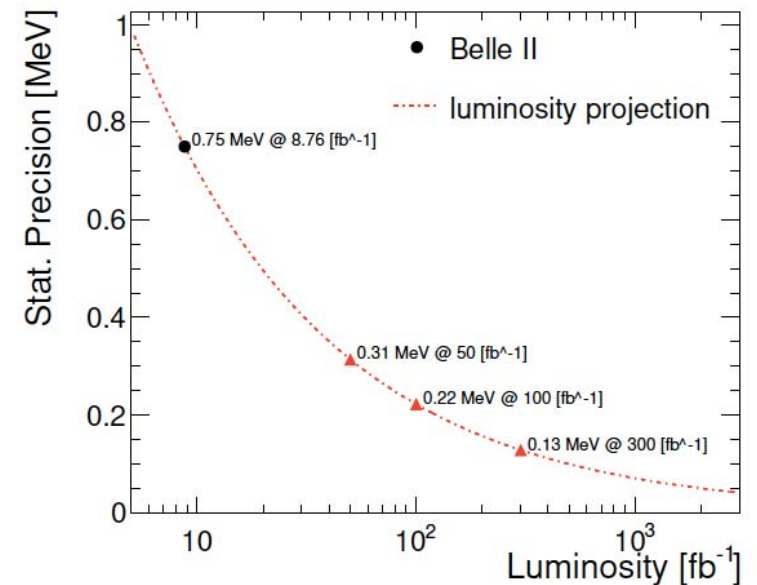

Charm physics, example

Three wrong-sign D decay modes clearly observed, including modes with π^0 . These can be used for D-Dbar mixing measurements in the future.

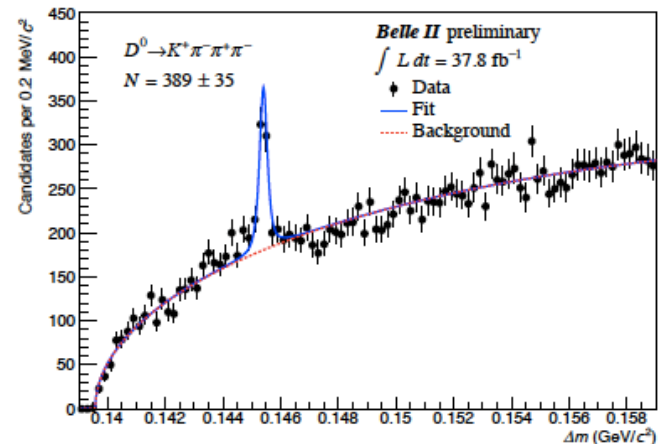
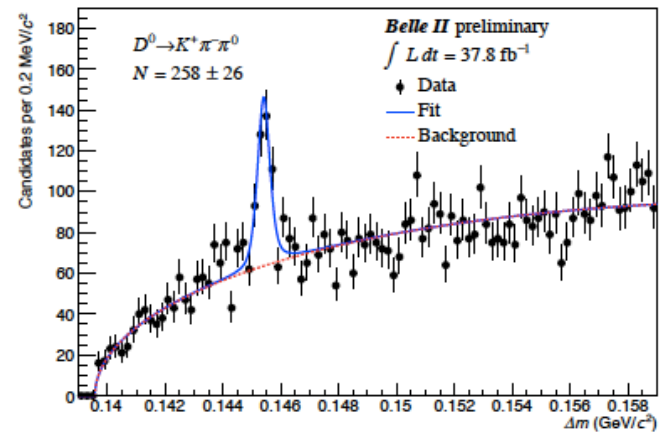
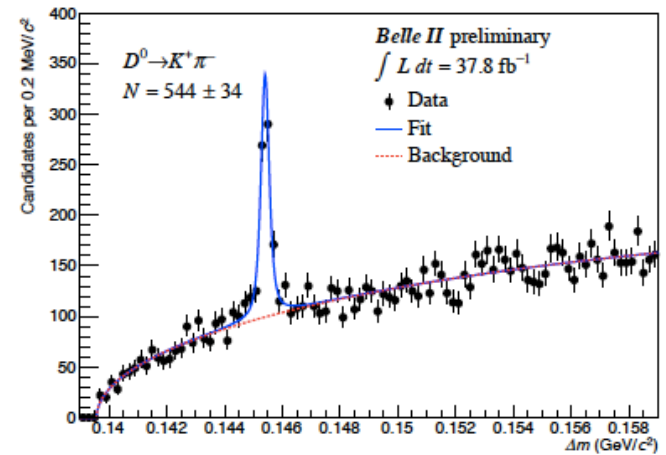
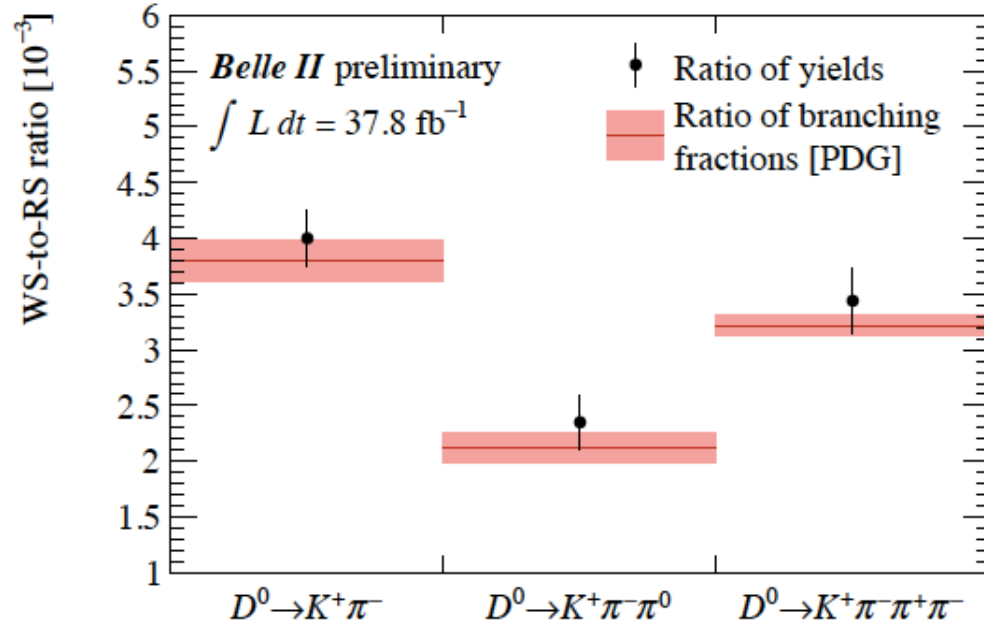

Updated plan for SuperKEKB submitted to the MEXT Roadmap Committee

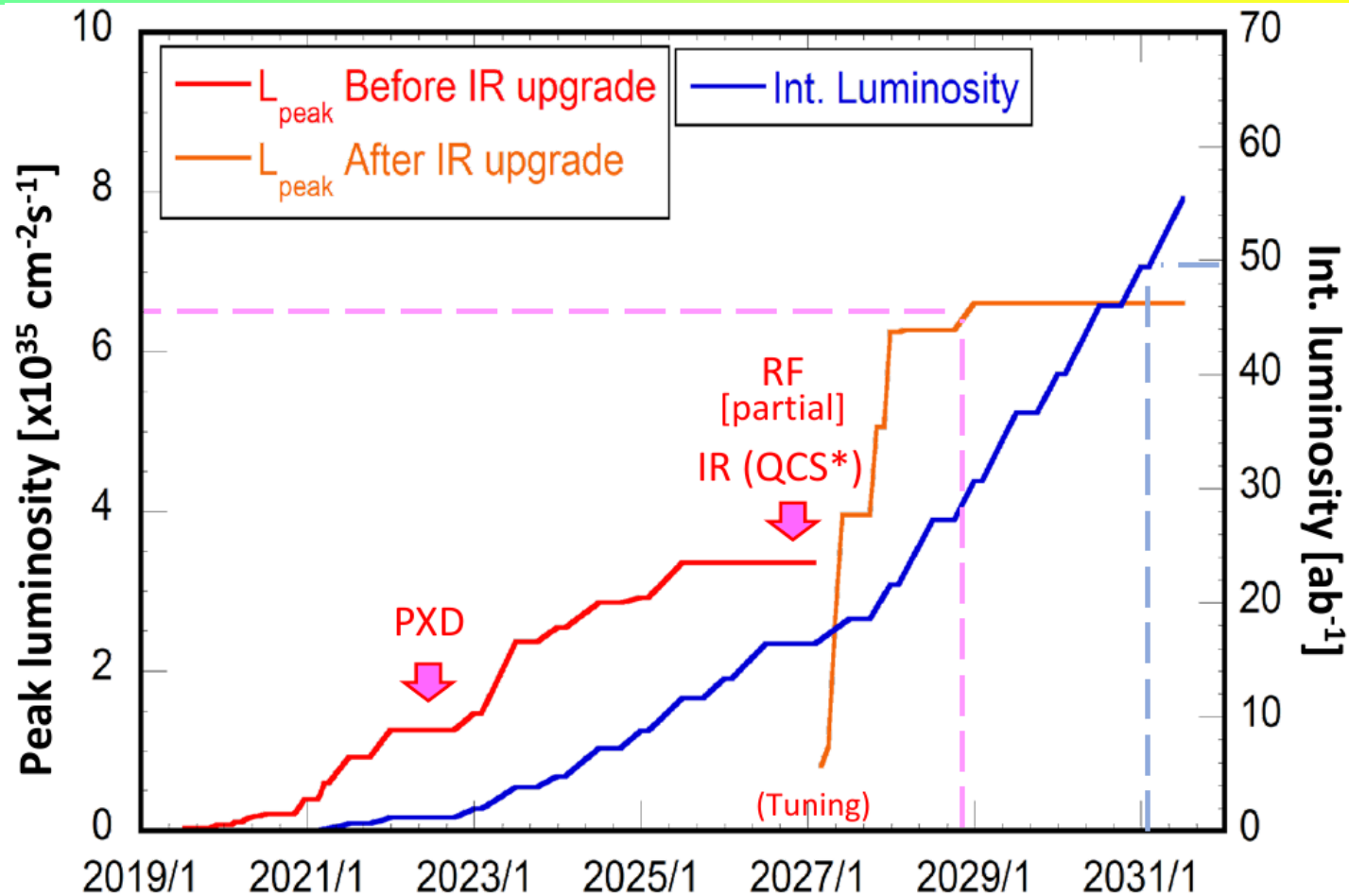

Two steps:

Intermediate luminosity ($1 \times 10^{35} / \text{cm}^2/\text{sec}$, 5 ab^{-1});

High Luminosity ($6 \times 10^{35} / \text{cm}^2/\text{sec}$, 50 ab^{-1}) with a detector upgrade



A very strong group of ~1050 highly motivated scientists from 26 countries!

Peter Križan, Ljubljana

<https://arxiv.org/abs/1808.10567>

Outcome of the B2TIP (Belle II Theory Interface) Workshops
Emphasis is on New Physics (NP) reach.

Strong participation from theory community,
lattice QCD community and Belle II experimenters.
689 pages, published by Oxford University Press

KEK Preprint 2018-27
BELLE2-PAPER-2018-001
FERMILAB-PUB-18-398-T
JLAB-THY-18-2780
INT-PUB-18-047
UWThPh 2018-26

The Belle II Physics Book

E. Kou^{74,¶,†}, P. Urquijo^{143,§,†}, W. Altmannshofer^{133,¶}, F. Beaujean^{78,¶}, G. Bell^{120,¶},
M. Beneke^{112,¶}, I. I. Bigi^{146,¶}, F. Bishara^{148,16,¶}, M. Blanke^{49,50,¶}, C. Bobeth^{111,112,¶},
M. Bona^{150,¶}, N. Brambilla^{112,¶}, V. M. Braun^{43,¶}, J. Brod^{110,133,¶}, A. J. Buras^{113,¶},
H. Y. Cheng^{44,¶}, C. W. Chiang^{91,¶}, M. Ciuchini^{58,¶}, G. Colangelo^{126,¶},
H. Czyz^{154,29,¶}, A. Datta^{144,¶}, F. De Fazio^{52,¶}, T. Deppisch^{50,¶}, M. J. Dolan^{143,¶},
J. Evans^{133,¶}, S. Fajfer^{107,139,¶}, T. Feldmann^{120,¶}, S. Godfrey^{7,¶}, M. Gronau^{61,¶},
Y. Grossman^{15,¶}, F. K. Guo^{41,132,¶}, U. Haisch^{148,11,¶}, C. Hanhart^{21,¶},
S. Hashimoto^{30,26,¶}, S. Hirose^{88,¶}, J. Hisano^{88,89,¶}, L. Hofer^{125,¶}, M. Hoferichter^{166,¶},
W. S. Hou^{91,¶}, T. Huber^{120,¶}, S. Jaeger^{157,¶}, S. Jahn^{82,¶}, M. Jamin^{124,¶},
J. Jones^{102,¶}, M. Jung^{111,¶}, A. L. Kagan^{133,¶}, F. Kahlhoefer^{1,¶},
J. F. Kamenik^{107,139,¶}, T. Kaneko^{30,26,¶}, Y. Kiyo^{63,¶}, A. Kokulu^{112,138,¶},
N. Kosnik^{107,139,¶}, A. S. Kronfeld^{20,¶}, Z. Ligeti^{19,¶}, H. Logan^{7,¶}, C. D. Lu^{41,¶},
V. Lubicz^{151,¶}, F. Mahmoudi^{140,¶}, K. Maltman^{171,¶}, S. Mishima^{30,¶}, M. Misiak^{164,¶},

Summary

- Belle II is working well and is now producing physics.
- SuperKEKB has broken the world-luminosity record and is now entering the “Super B Factory” regime.
- World-leading results already on the dark sector (Search for $Z' \rightarrow$ invisible and ALPs publications)
- Rediscovering many of the signals seen at the B factories: semileptonic decays, improving FEI, establishing “missing energy” and time-dependent capabilities, and beginning to see hints of time-dependent CP violation. Need more data to make further progress
- Expect a new, exciting era of discoveries, and a friendly competition and complementarity of Belle II and LHCb