

Flavour Physics with High-Luminosity Experiments

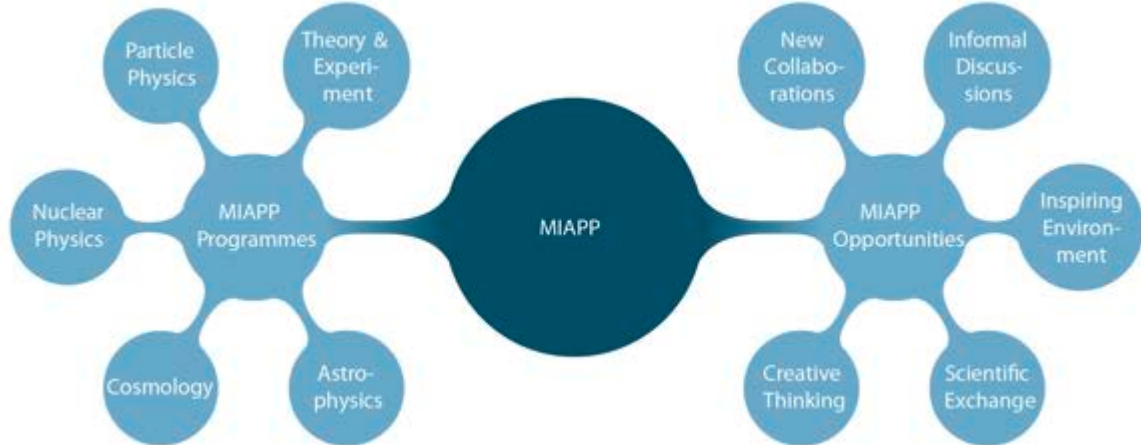

Belle II: status and plans

Peter Križan

University of Ljubljana and J. Stefan Institute



University
of Ljubljana

"Jožef Stefan"
Institute

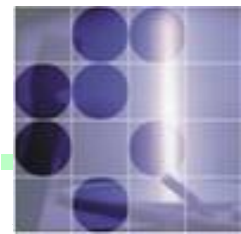

Contents

- Accelerator status
- Detector construction: status and schedule
- Commissioning
- Outlook

Need $O(100x)$ more data \rightarrow Next generation B-factories

Peak Luminosity Trends (e^+e^- collider)

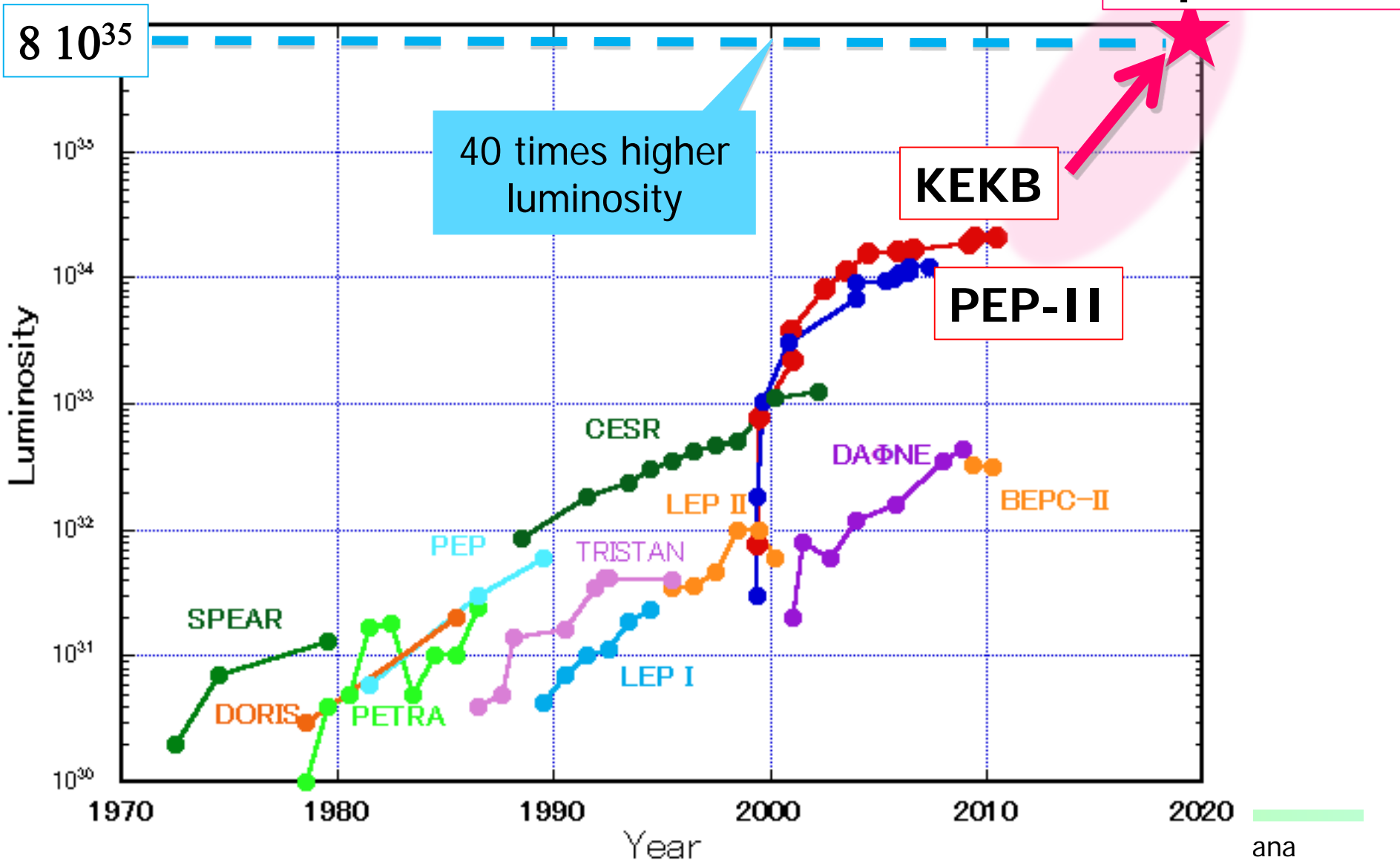

How to increase the luminosity?

$$L = \frac{\gamma_{e\pm}}{2er_e} \left(1 + \frac{\sigma_y^*}{\sigma_x^*} \right) \left(\frac{I_{e\pm} \xi_{\zeta_y}^{e\pm}}{\beta_y^*} \right) \left(\frac{R_L}{R_{\xi_y}} \right)$$

Lorentz factor (points to $\gamma_{e\pm}$)
 Beam current (points to $I_{e\pm}$)
 Beam-beam parameter (points to $\xi_{\zeta_y}^{e\pm}$)
 Classical electron radius (points to $2er_e$)
 Beam size ratio@IP (points to $\frac{\sigma_y^*}{\sigma_x^*}$)
 1 - 2 % (flat beam)
 Vertical beta function@IP (points to β_y^*)
 Lumi. reduction factor (crossing angle) & Tune shift reduction factor (hour glass effect) (points to $\frac{R_L}{R_{\xi_y}}$)
 0.8 - 1 (short bunch)

- (1) Smaller b_y^*
- (2) Increase beam currents
- (3) Increase x_y

“Nano-Beam” scheme

Collision with very small spot-size beams

Invented by Pantaleo Raimondi for SuperB

How big is a nano-beam ?

How to go from an excellent accelerator with world record performance – KEKB – to a 40x times better, more intense facility?

In KEKB, colliding electron and positron beams were already **much thinner than a human hair...**

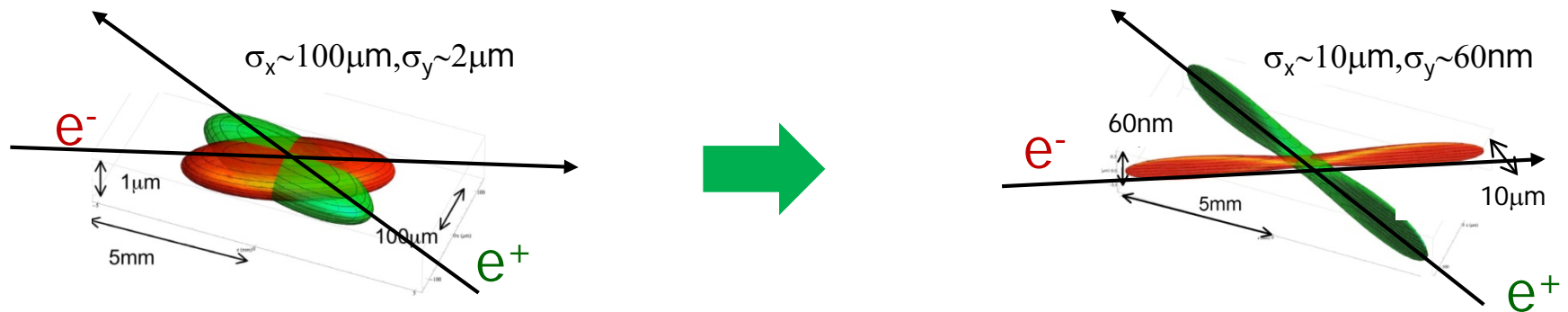

... For a 40x increase in intensity you have to make the beam as thin as a **few x100 atomic layers!**

KEKB → SuperKEKB

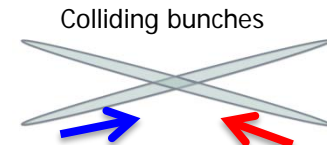
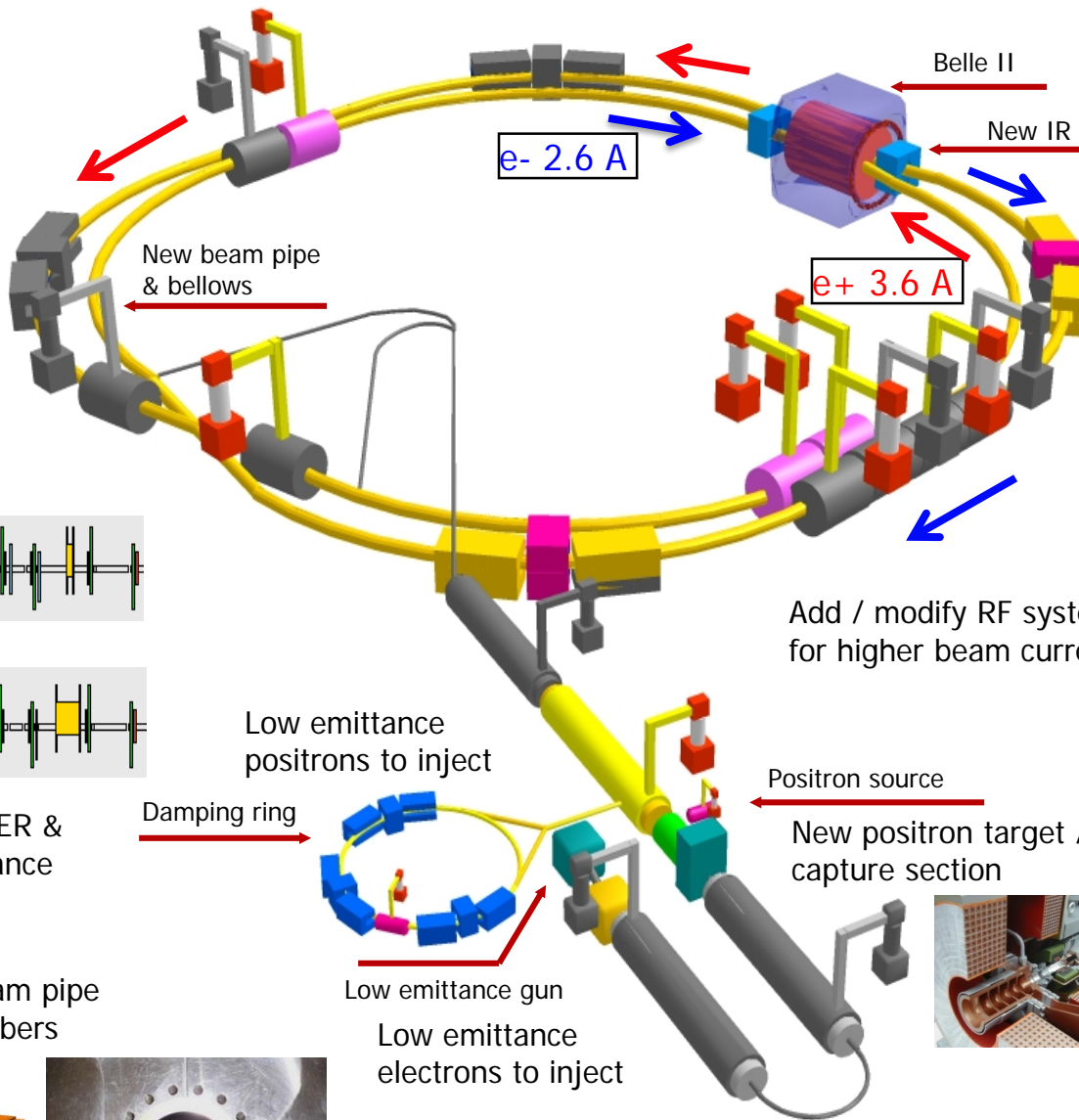
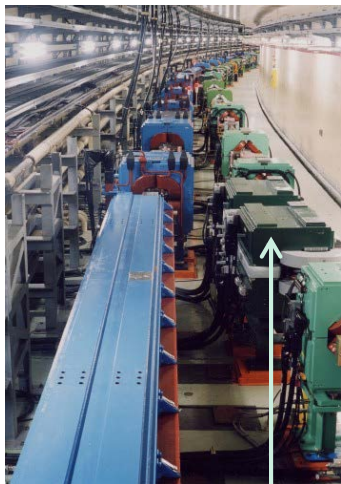

Colliding bunches
New superconducting / permanent final focusing quads near the IP



Replace short dipoles with longer ones (LER)

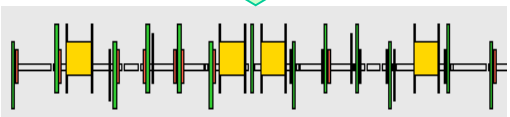
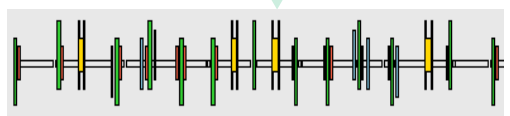

Redesign the lattices of HER & LER to squeeze the emittance

TiN-coated beam pipe with antechambers

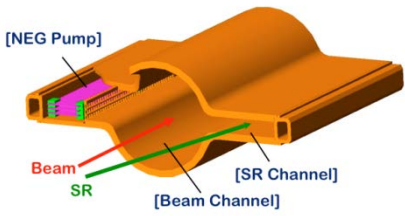

Add / modify RF systems for higher beam current

Low emittance positrons to inject

Damping ring

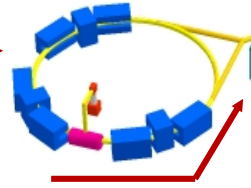

Positron source

New positron target / capture section

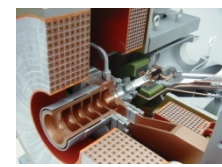

Low emittance gun
Low emittance electrons to inject

To get x40 higher luminosity



Requirements for the Belle II detector

Critical issues at $L = 8 \times 10^{35}/\text{cm}^2/\text{sec}$

- ▶ **Higher background ($\times 10\text{-}20$)**
 - radiation damage and occupancy
 - fake hits and pile-up noise in the EM
- ▶ **Higher event rate ($\times 10$)**
 - higher rate trigger, DAQ and computing
- ▶ **Require special features**
 - low $p \mu$ identification $\leftarrow s \mu \mu$ recon. eff.
 - hermeticity $\leftarrow \nu$ "reconstruction"

Solutions:

- ▶ Replace inner layers of the vertex detector with a pixel detector.
- ▶ Replace inner part of the central tracker with a silicon strip detector.
- ▶ Better particle identification device
- ▶ Replace endcap calorimeter crystals
- ▶ Faster readout electronics and computing system.

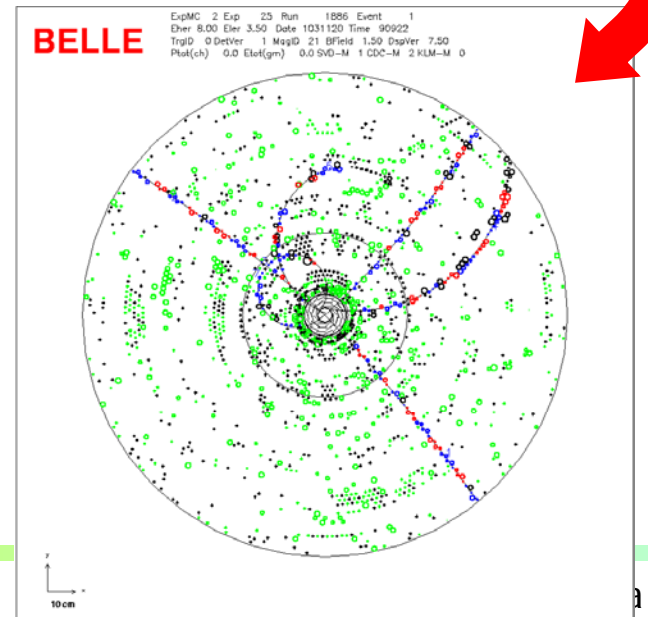
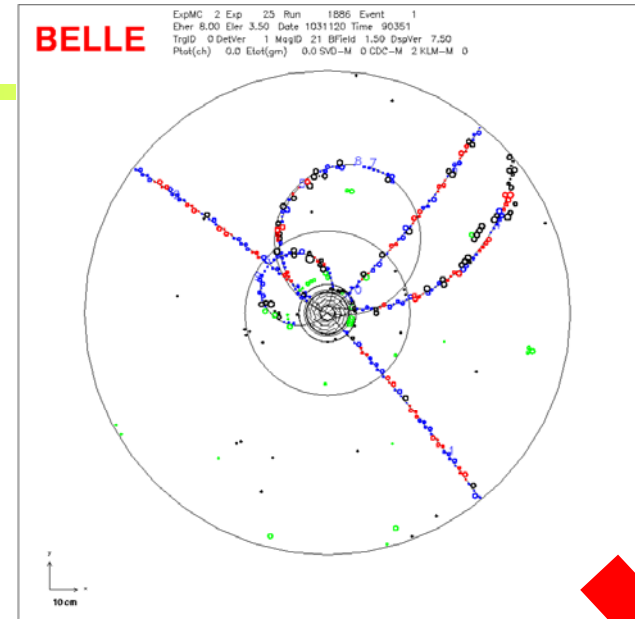

Belle II Detector

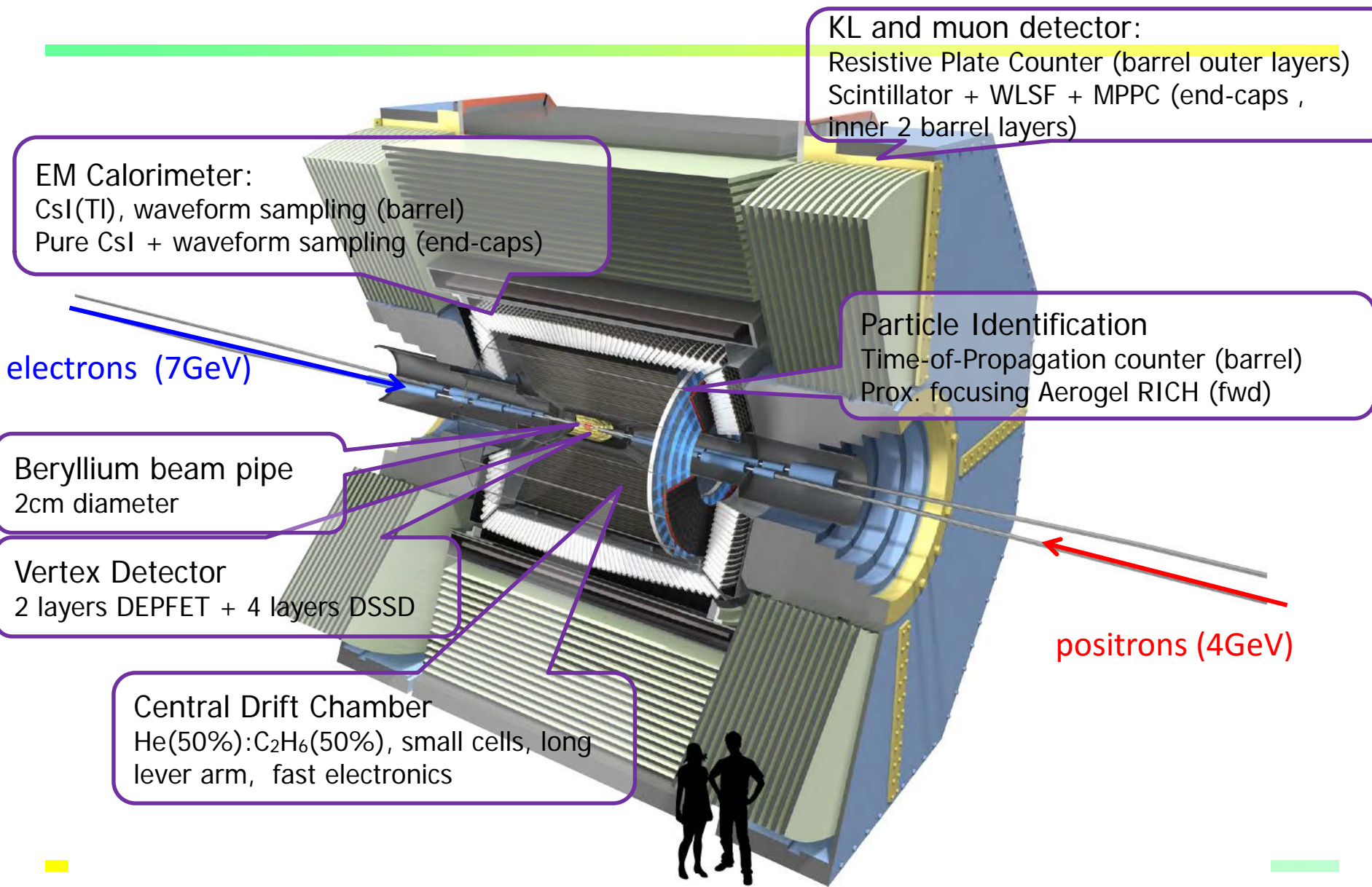

KL and muon detector:
Resistive Plate Counter (barrel outer layers)
Scintillator + WLSF + MPPC (end-caps ,
inner 2 barrel layers)

EM Calorimeter:
CsI(Tl), waveform sampling (barrel)
Pure CsI + waveform sampling (end-caps)

electrons (7GeV)

Particle Identification
Time-of-Propagation counter (barrel)
Prox. focusing Aerogel RICH (fwd)

Beryllium beam pipe
2cm diameter

Vertex Detector
2 layers DEPFET + 4 layers DSSD

positrons (4GeV)

Central Drift Chamber
He(50%):C₂H₆(50%), small cells, long
lever arm, fast electronics

Belle II Detector (in comparison with Belle)

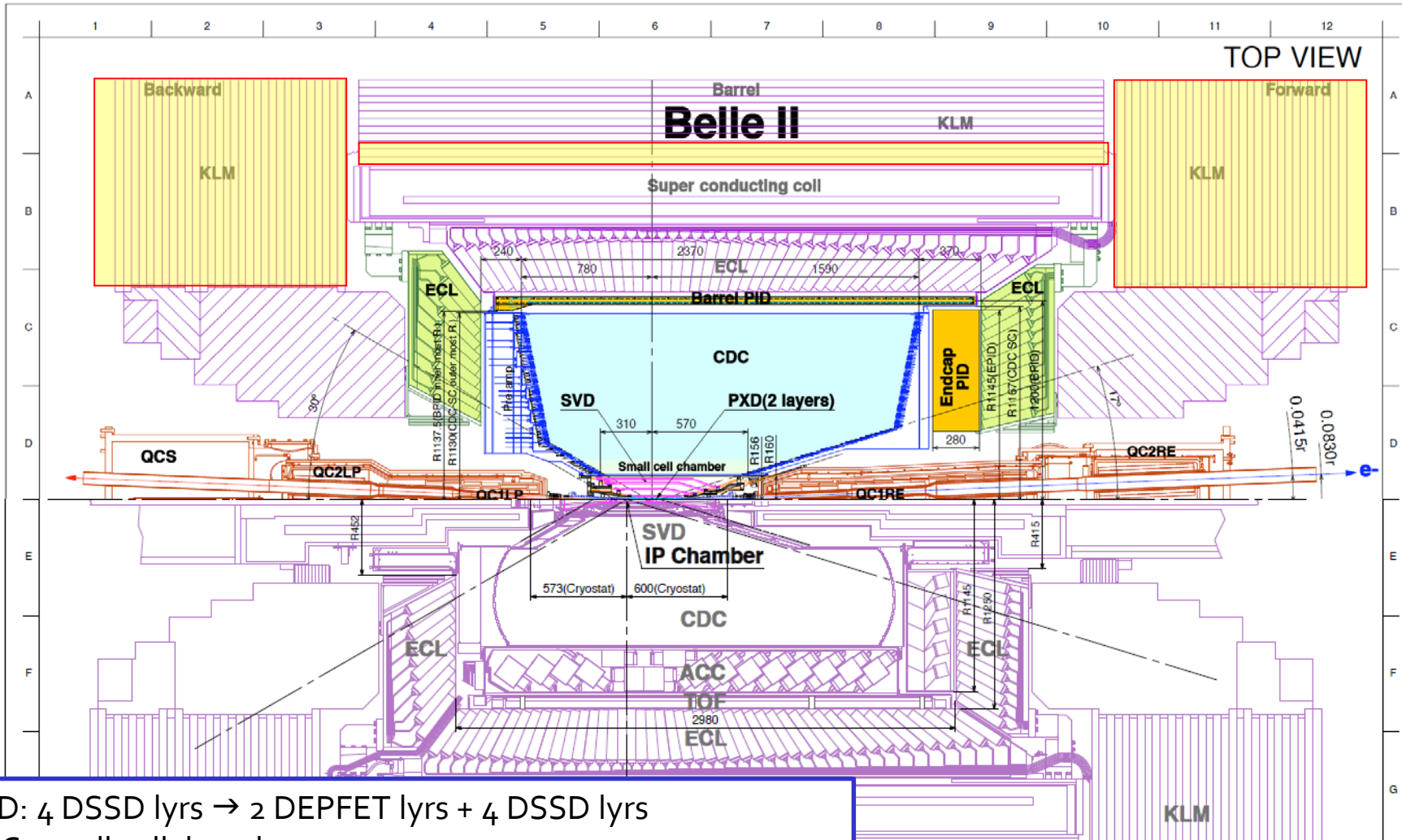

SVD: 4 DSSD lyrs → 2 DEPFET lyrs + 4 DSSD lyrs
 CDC: small cell, long lever arm
 ACC+TOF → TOP+A-RICH
 ECL: waveform sampling (+pure CsI for endcaps)
 KLM: RPC → Scintillator +MPPC (endcaps, barrel inner 2 lyrs)

In colours: new components

Belle II Detector – vertex region

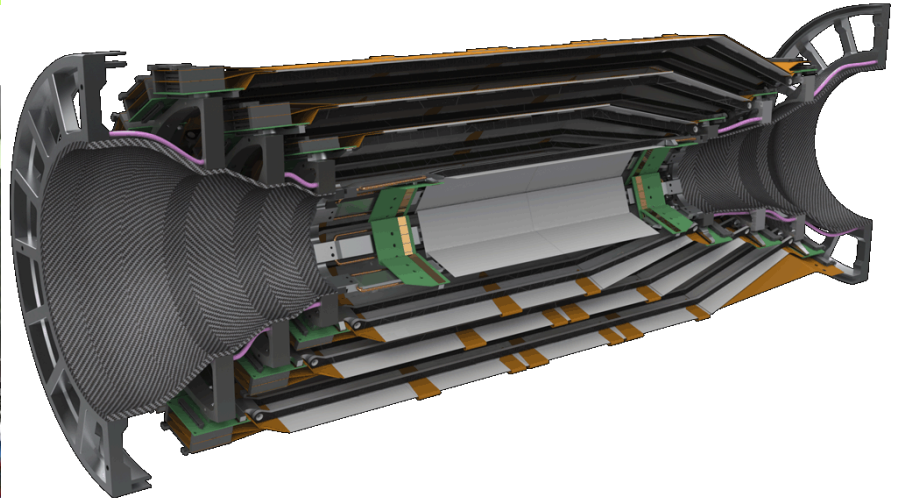
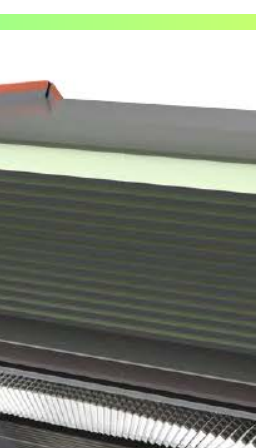

Beryllium beam pipe
2cm diameter

Vertex Detector
2 layers pixel (DEPFET)
+ 4 layers DSSD

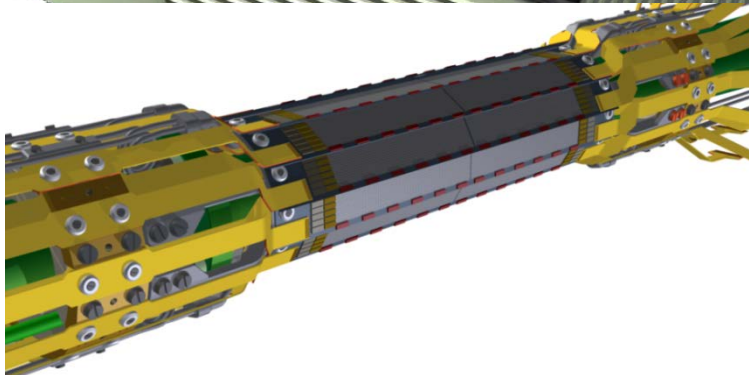
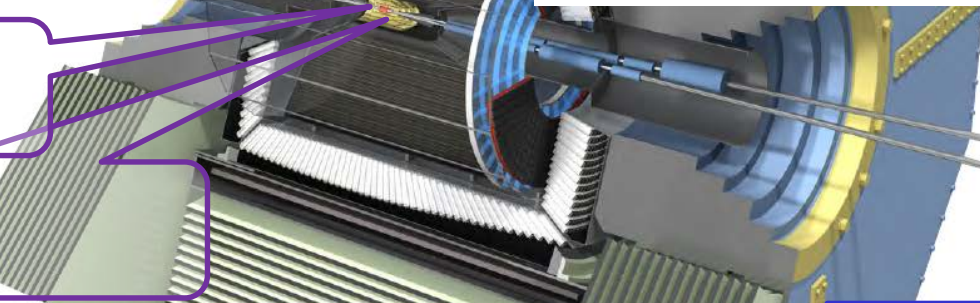

| | | |
|-----------|---------|--------------------|
| Beam Pipe | | $r = 10\text{mm}$ |
| DEPFET | | |
| | Layer 1 | $r = 14\text{mm}$ |
| | Layer 2 | $r = 22\text{mm}$ |
| DSSD | | |
| | Layer 3 | $r = 38\text{mm}$ |
| | Layer 4 | $r = 80\text{mm}$ |
| | Layer 5 | $r = 115\text{mm}$ |
| | Layer 6 | $r = 140\text{mm}$ |

Pixel detector: 2 layers of DEPFET sensors

Mechanical mockup of the pixel detector

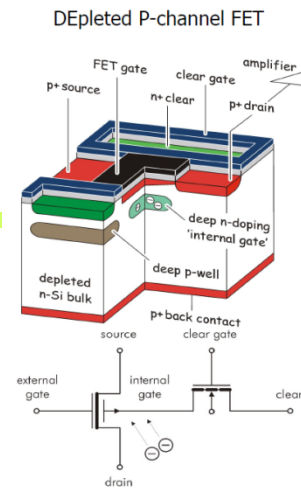

DEPFET sensor: developed at MPI Munich, produced at HLL

<http://aldebaran.hll.mpg.de/twiki/bin/view/DEPFET/WebHome>

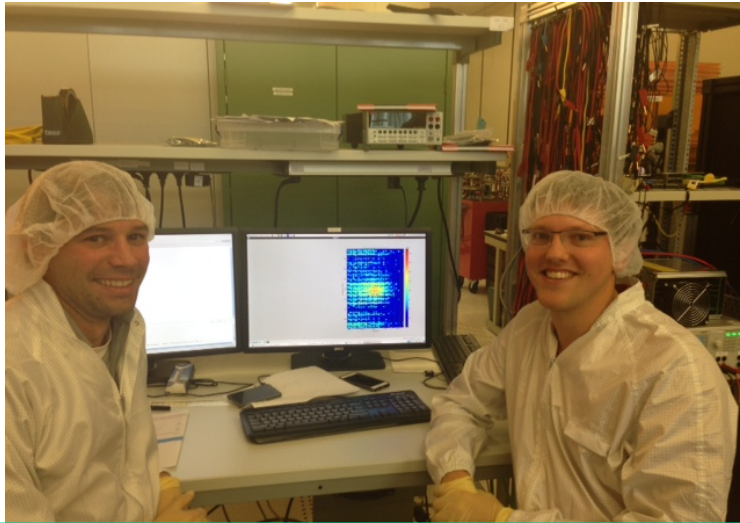

First laser light observed with the full size sensor

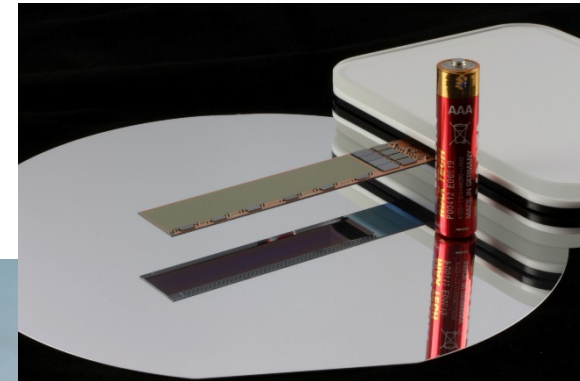
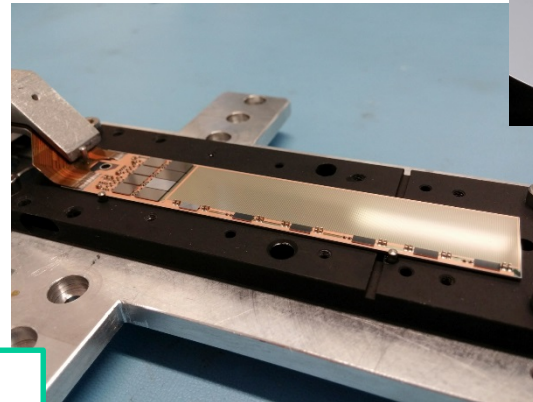

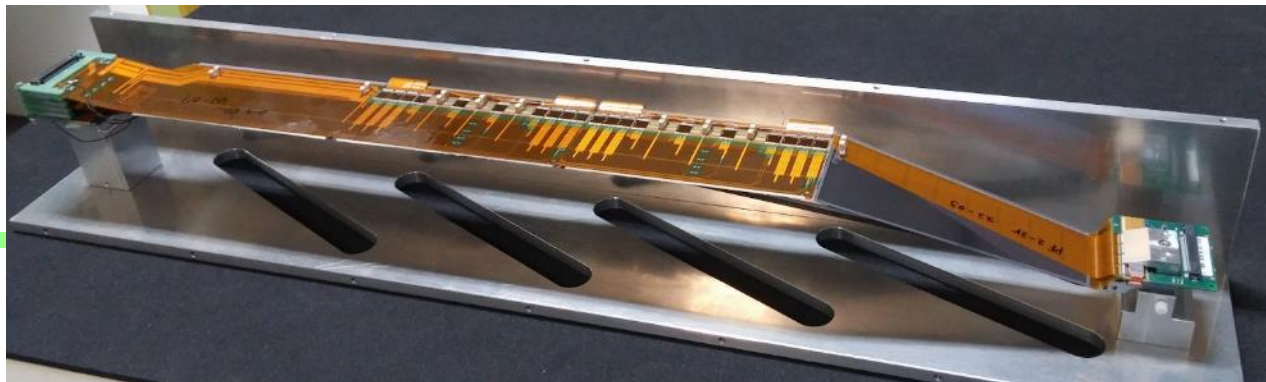

SVD: four layers of silicon microstrip detectors.

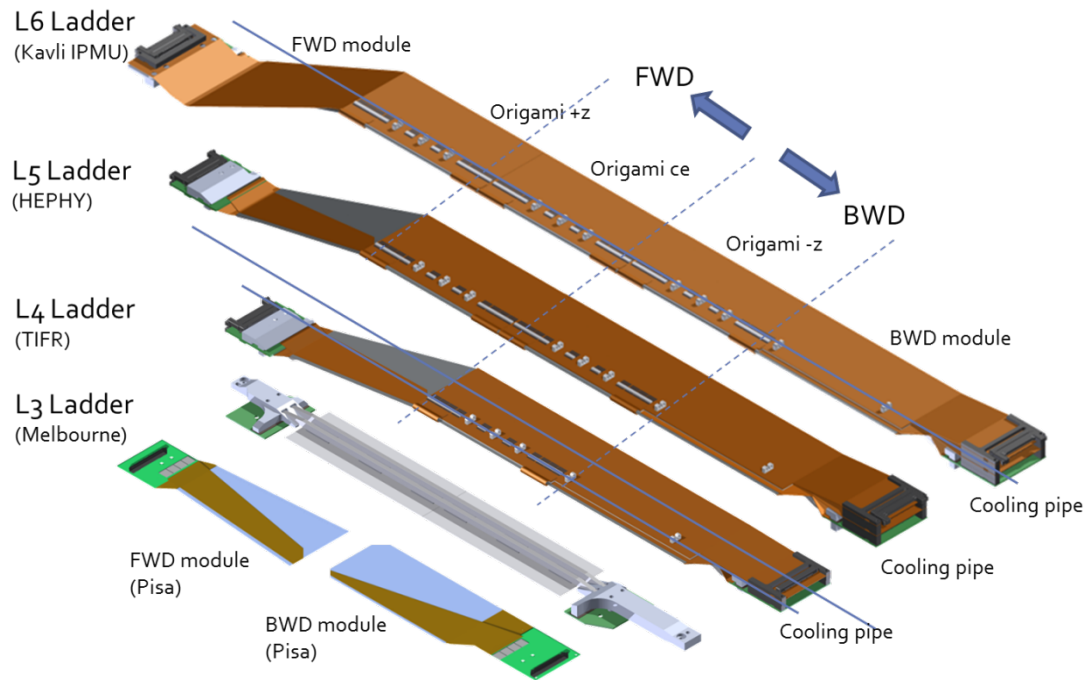

Belle II CDC

Wire Configuration

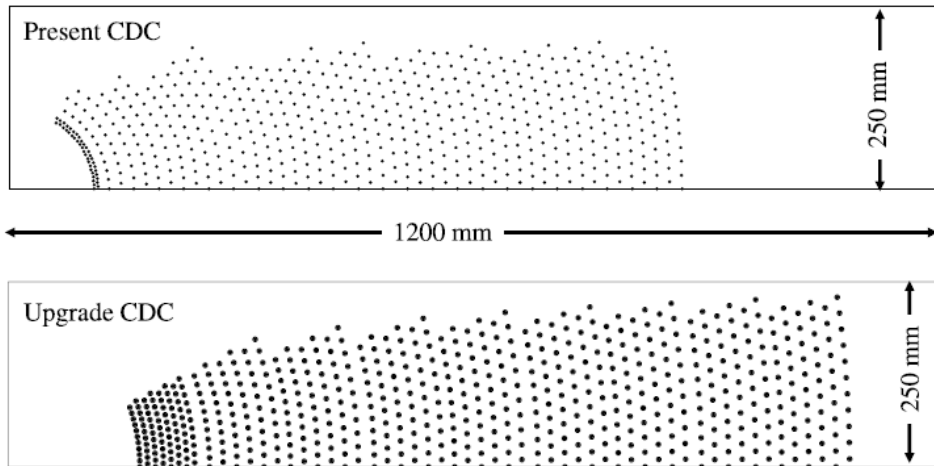

Much bigger than in Belle!

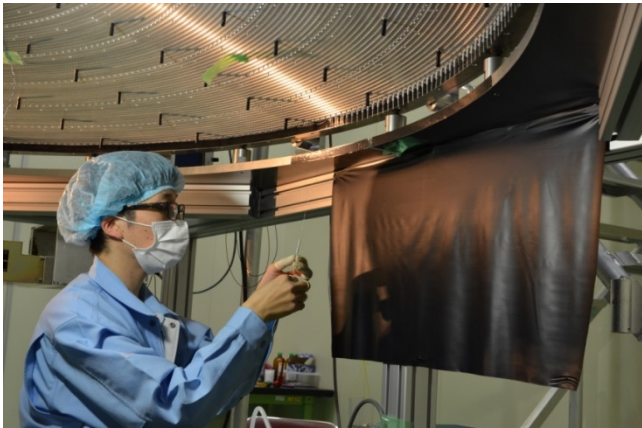

Wire stringing in a clean room

- thousands of wires,
- 1 year of work...

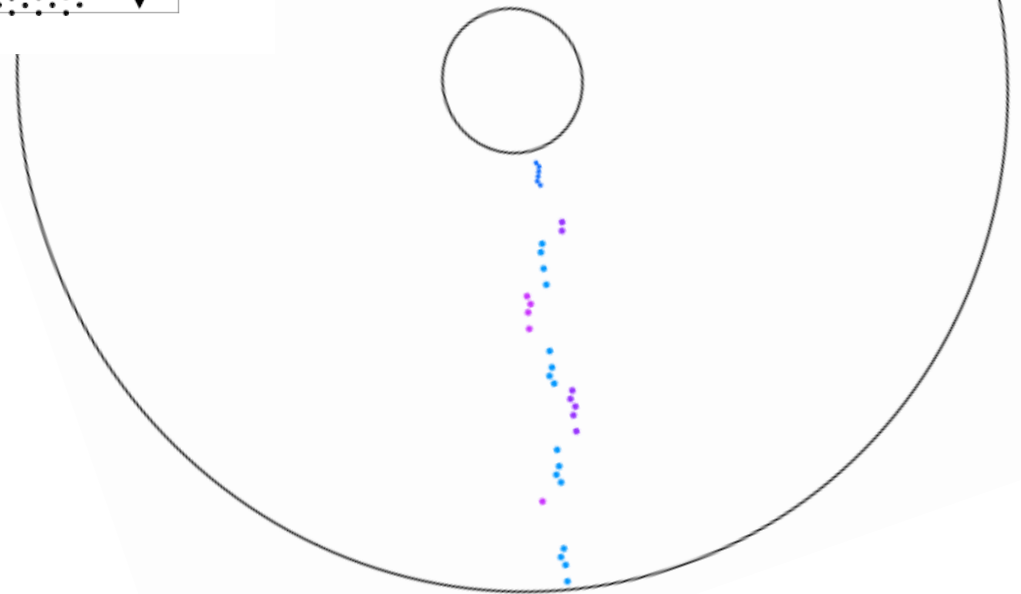

Being commissioned with cosmic rays.

Particle Identification Devices

Barrel PID: Time of Propagation Counter (TOP)

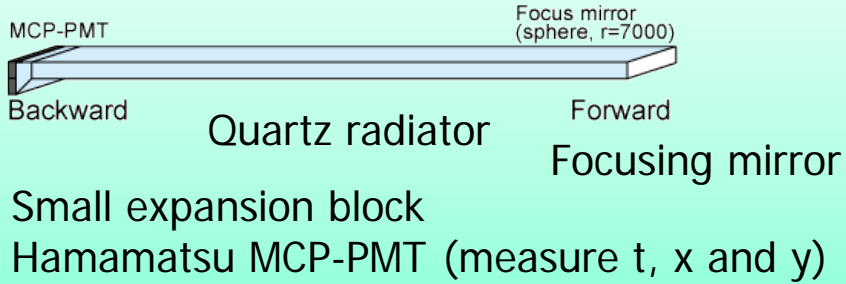

Endcap PID: Aerogel RICH (ARICH)

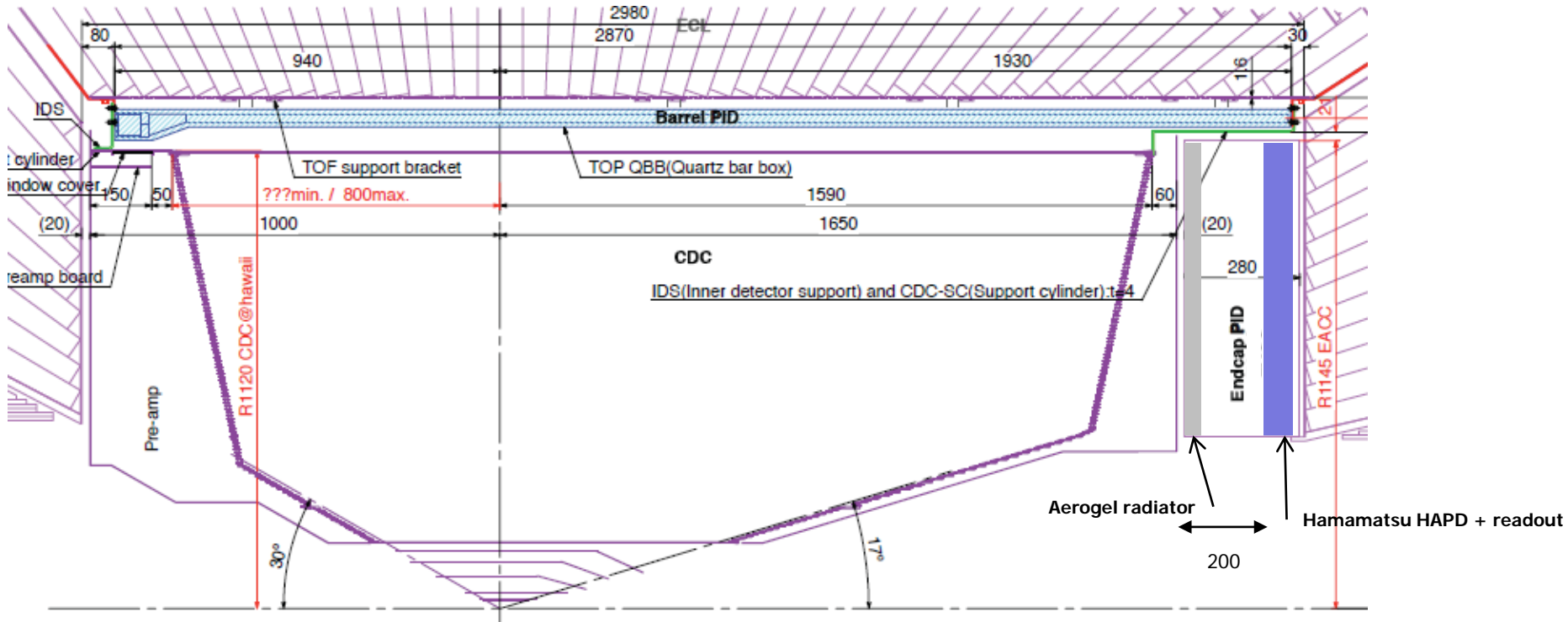
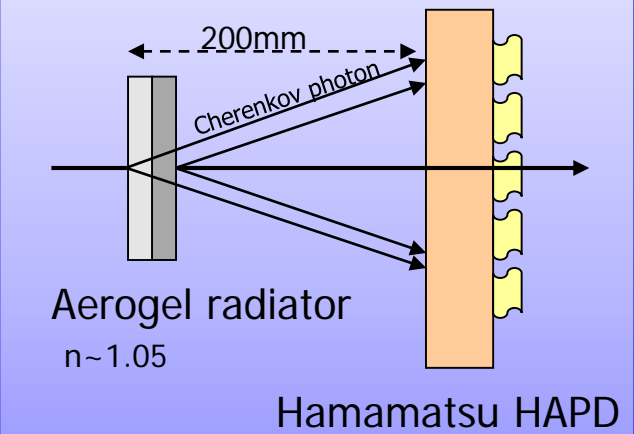

Aerogel RICH (endcap PID)

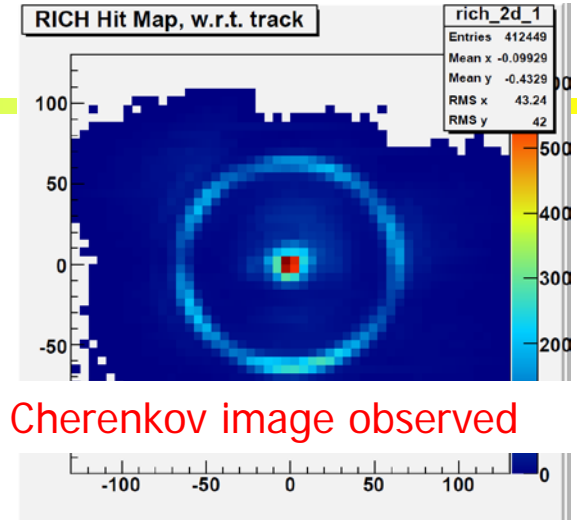
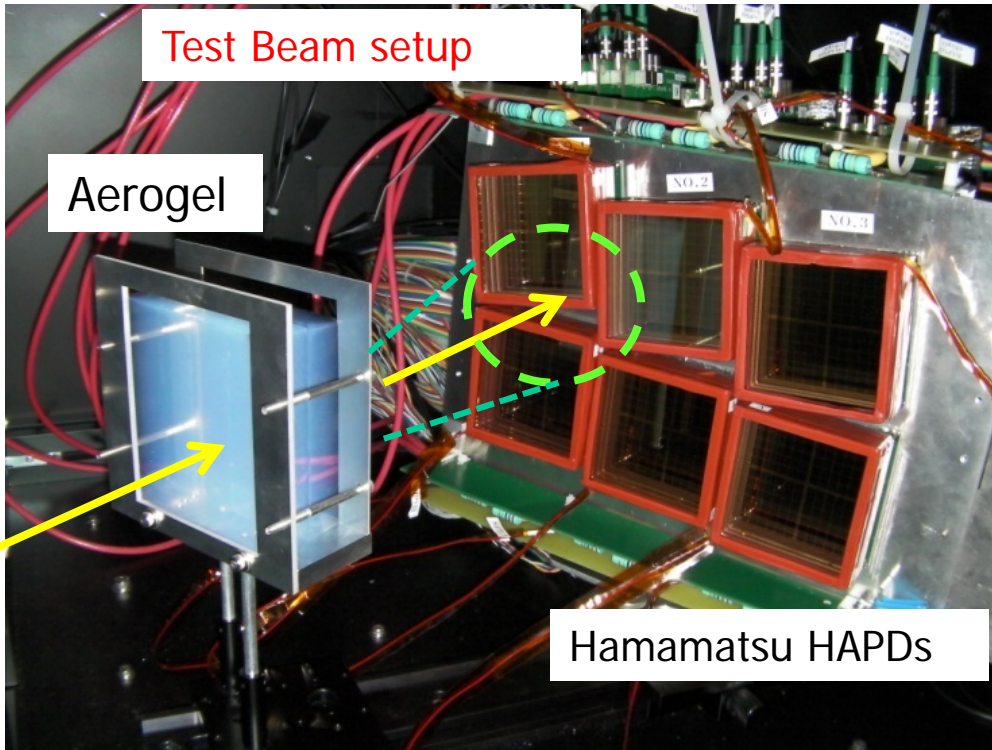

Clear Cherenkov image observed

Cherenkov angle distribution

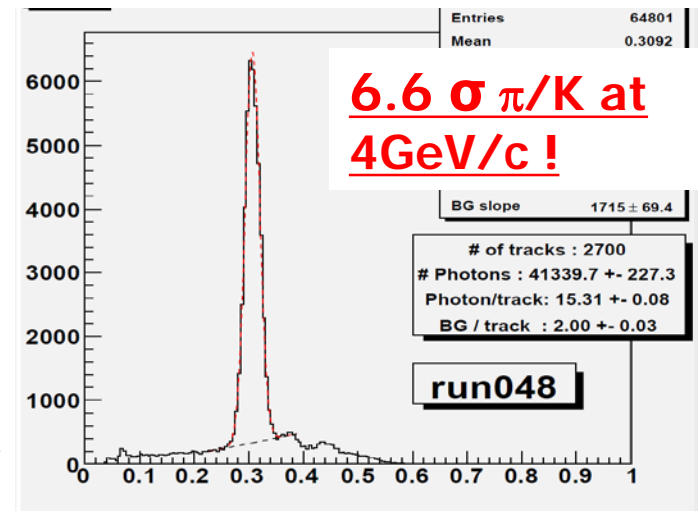

RICH with a novel "focusing" radiator – a two layer radiator

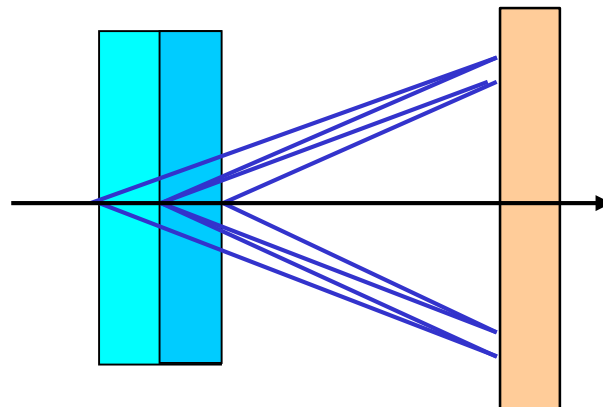

Employ multiple layers with different refractive indices → Cherenkov images from individual layers overlap on the photon detector.



Radiator with multiple refractive indices

How to increase the number of photons without degrading the resolution?

normal

→ stack two tiles with different refractive indices:
“focusing” configuration

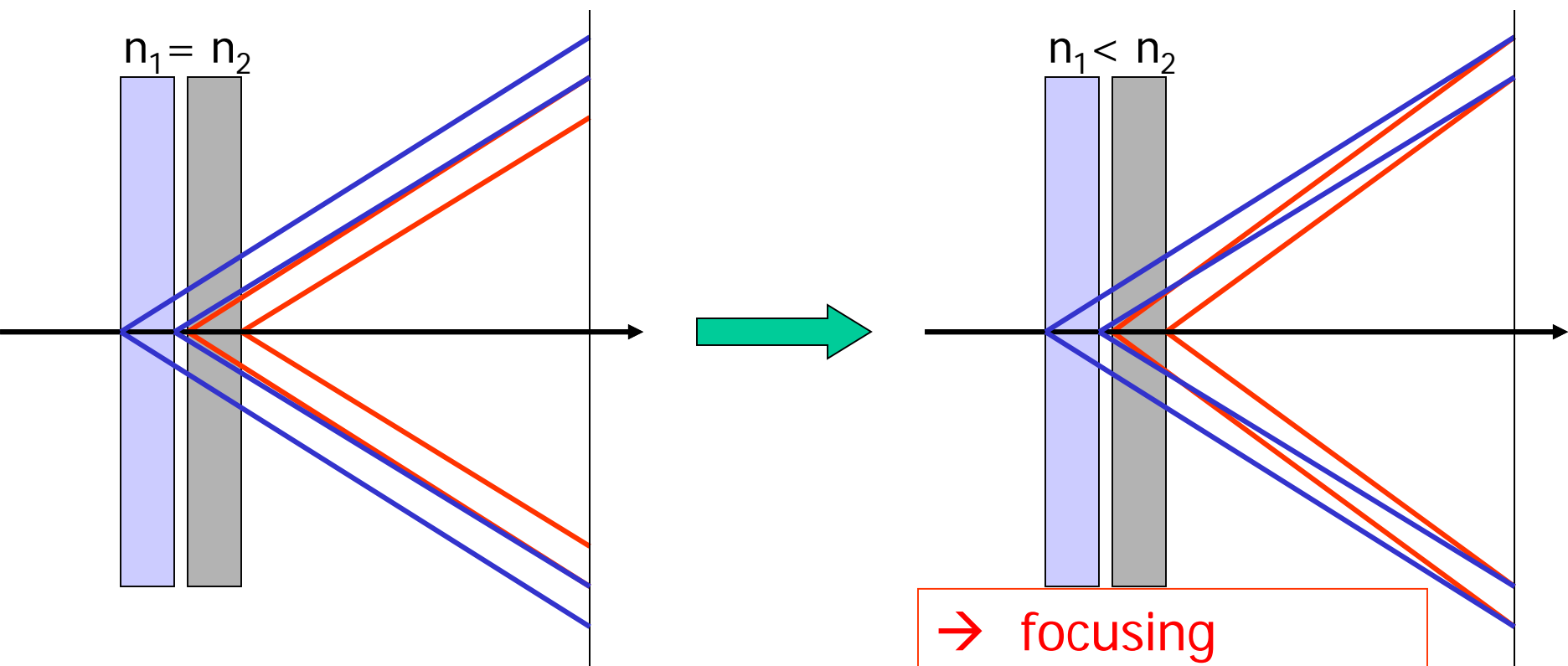

→ focusing

Such a configuration is only possible with aerogel (a form of Si_xO_y)
– material with a tunable refractive index between 1.01 and 1.13.



Focusing configuration – data

Increases the number of photons without degrading the resolution

4cm aerogel single index

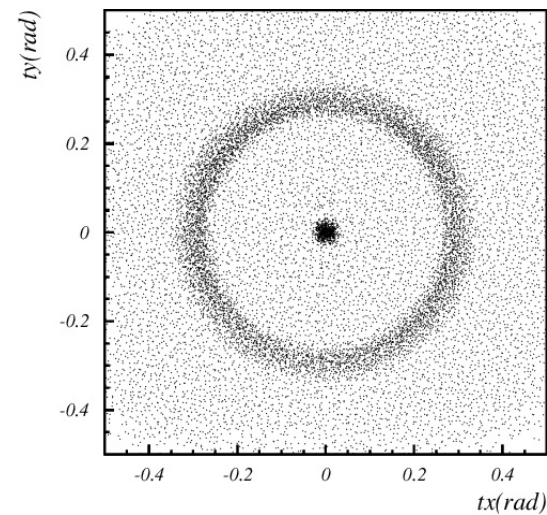
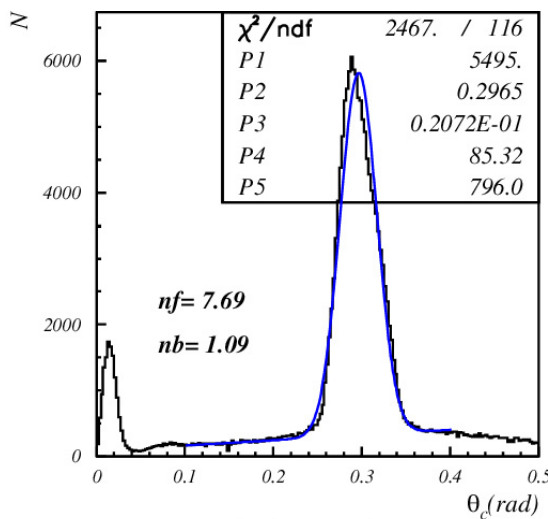
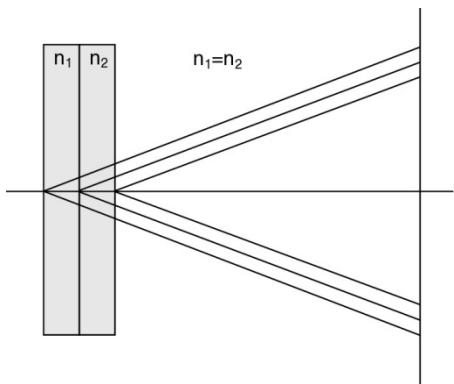

2+2cm aerogel

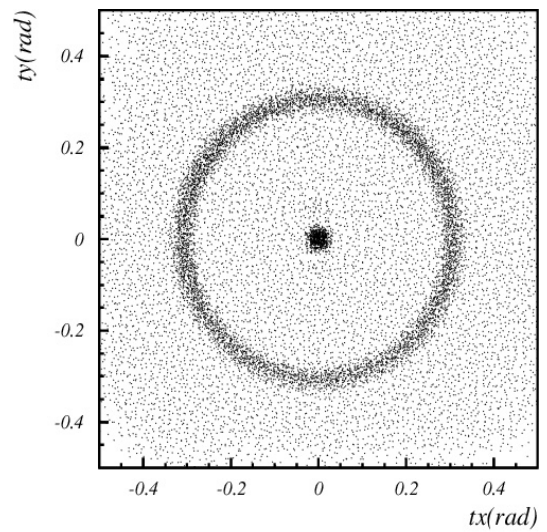
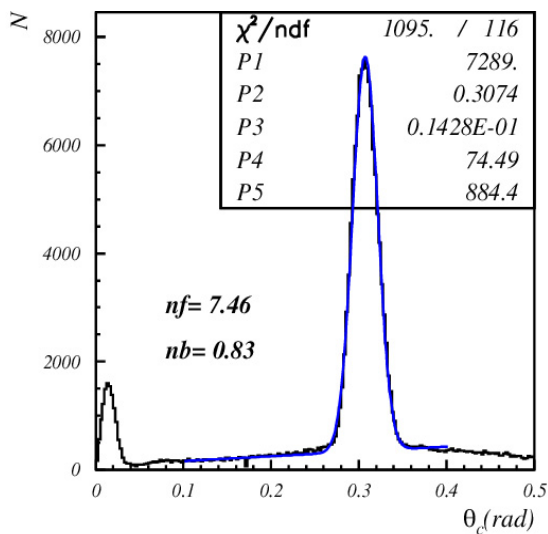
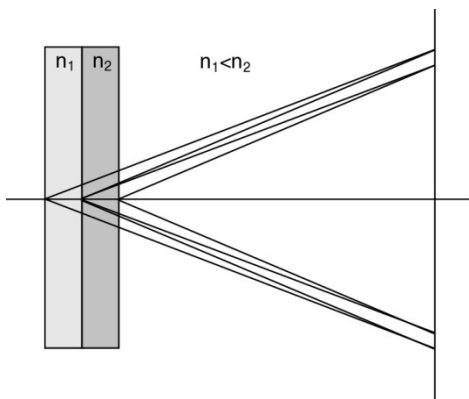

→ NIM A548 (2005) 383

Cherenkov detectors

Barrel PID: Time of Propagation Counter (TOP)

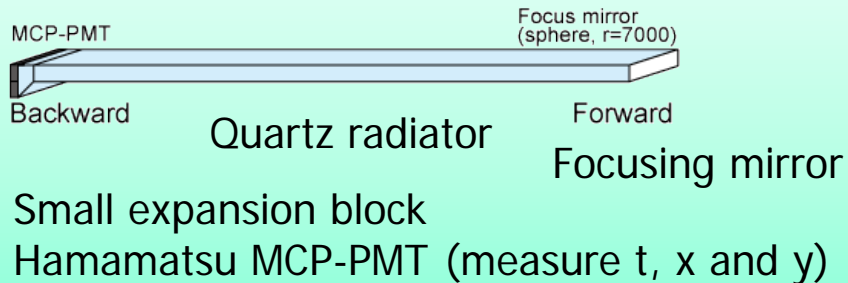

Endcap PID: Aerogel RICH (ARICH)

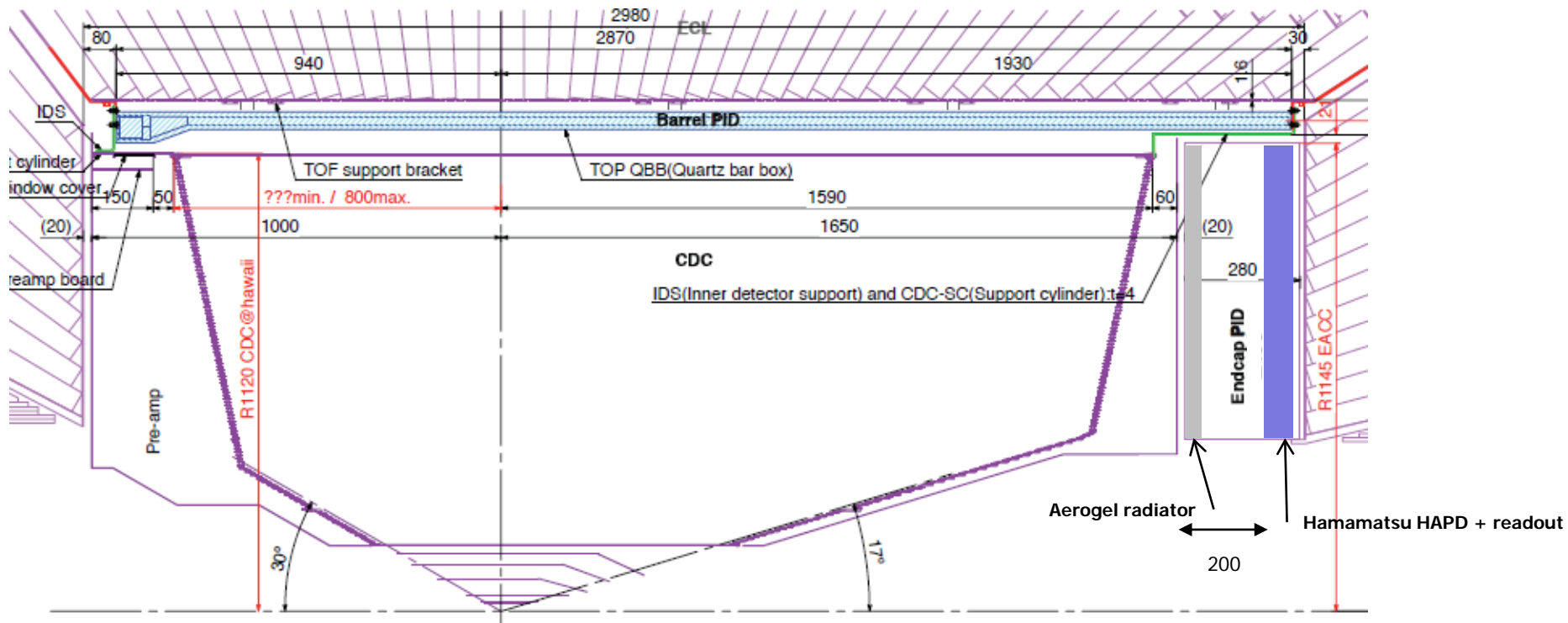
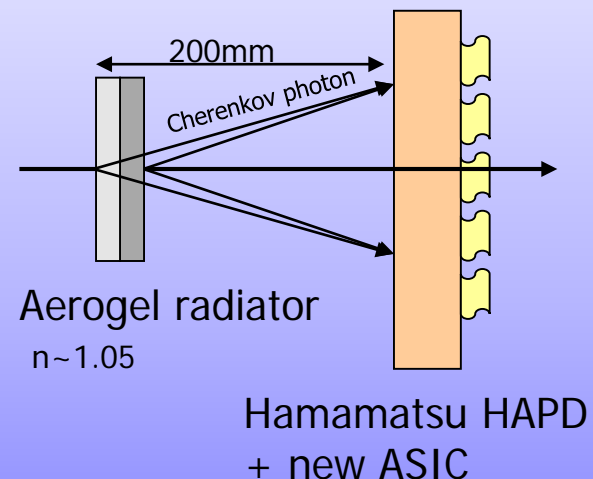

DIRC (@BaBar) - detector of internally reflected Cherenkov light

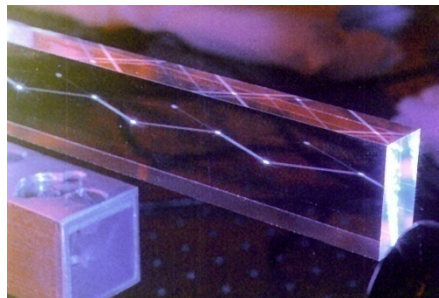
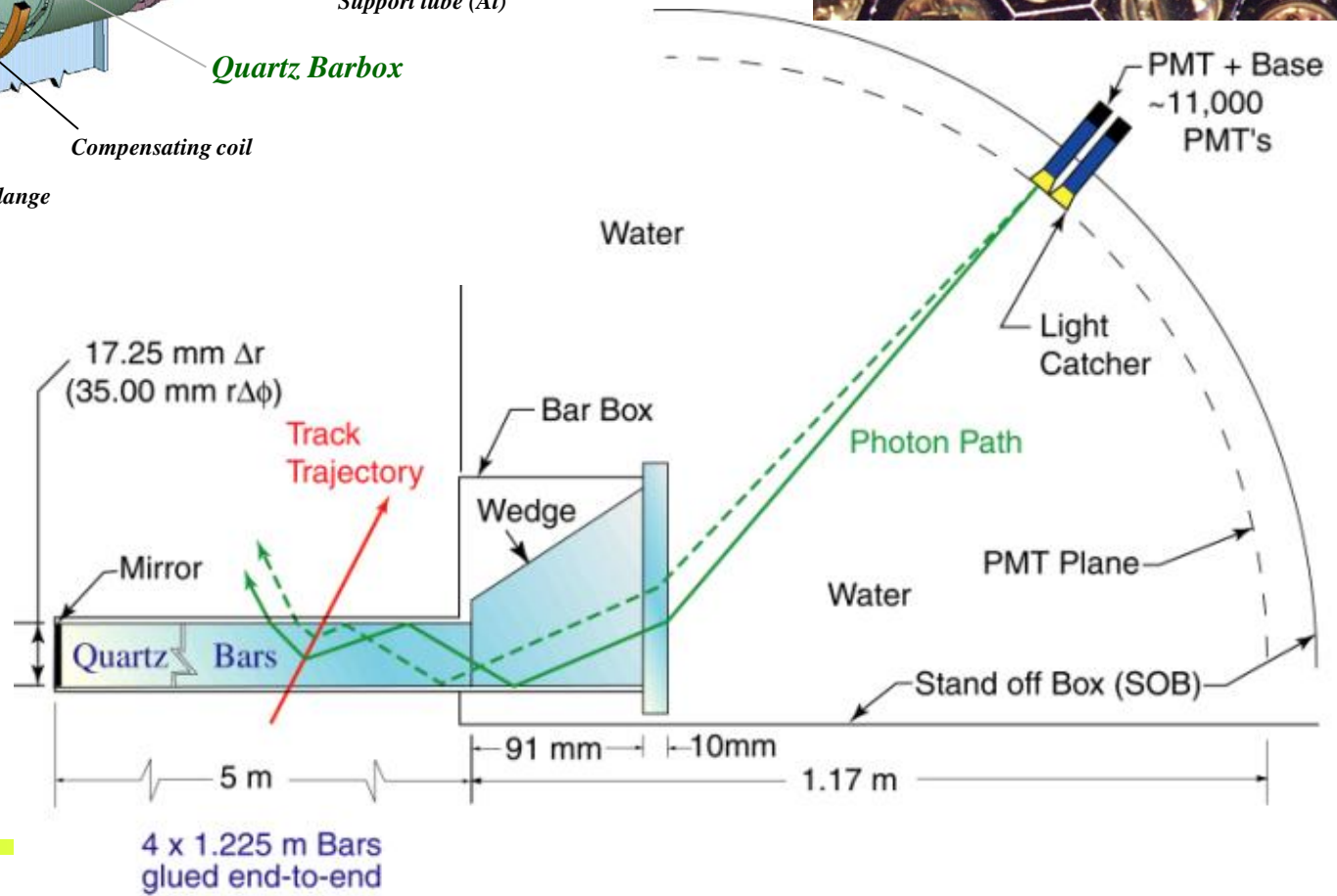
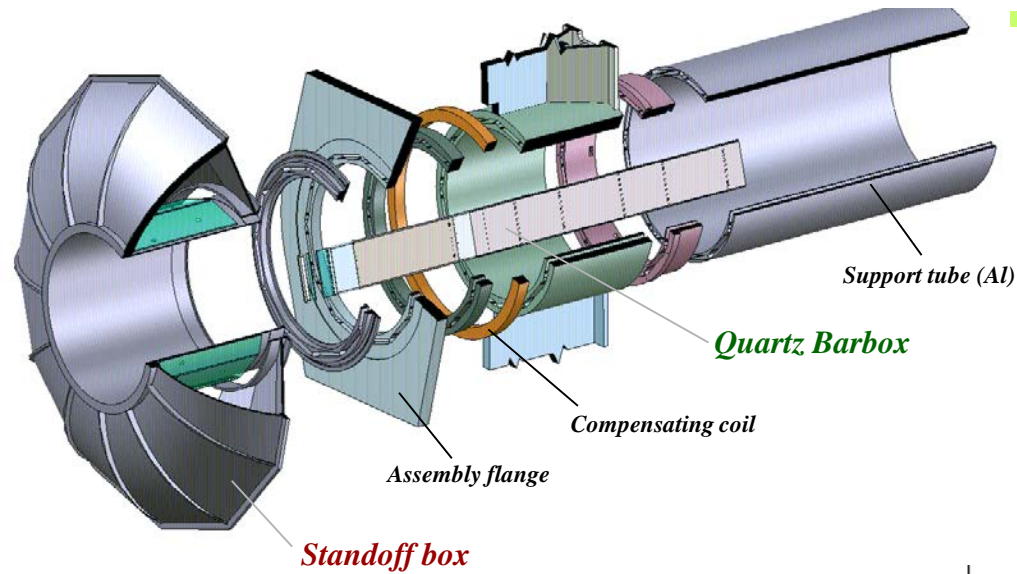
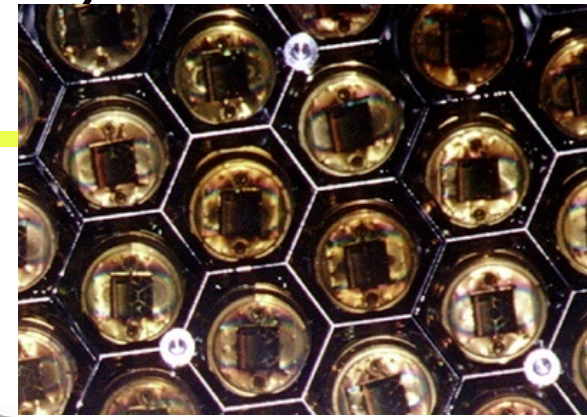

4 x 1.225 m Bars
glued end-to-end

Belle II Barrel PID: Time of propagation (TOP) counter

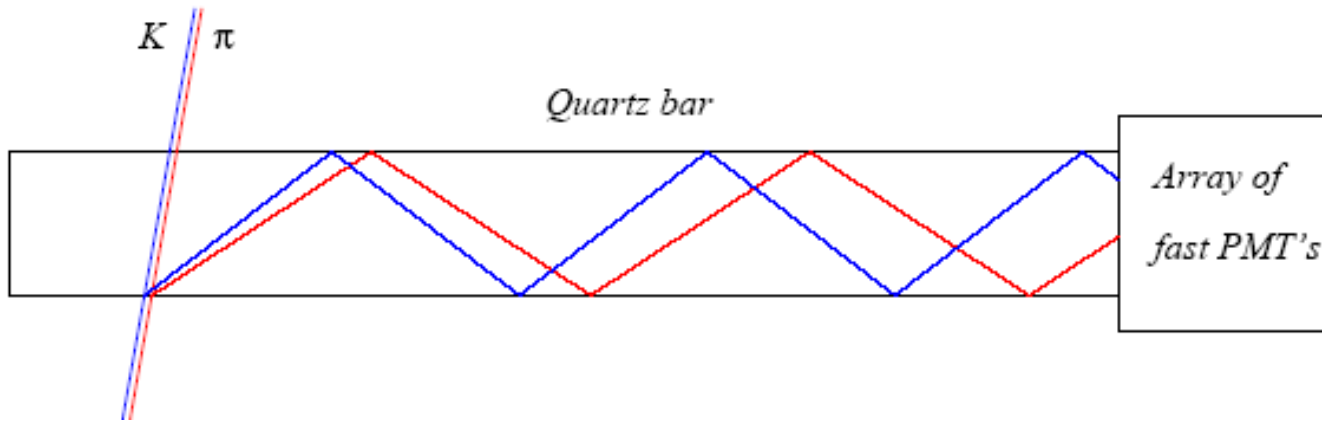

- Cherenkov ring imaging with **precise time measurement**.
- Uses internal reflection of Cherenkov ring images from quartz like the BaBar DIRC.
- Reconstruct Cherenkov angle from two hit coordinates and the time of propagation of the photon
 - Quartz radiator (2cm thick)
 - **Photon detector (MCP-PMT)**
 - Excellent time resolution ~ 40 ps
 - Single photon sensitivity in 1.5

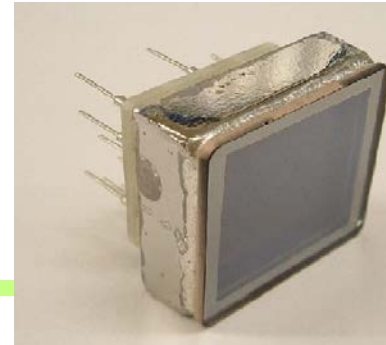
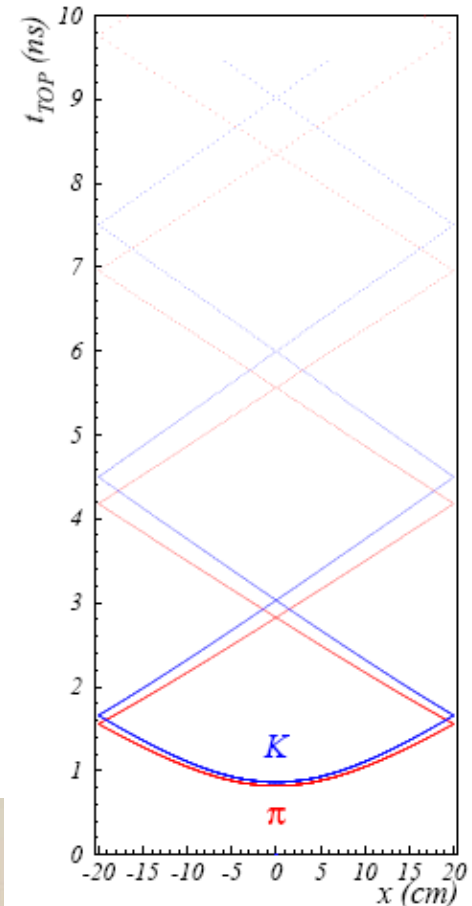

Barrel PID: Time of propagation (TOP) counter

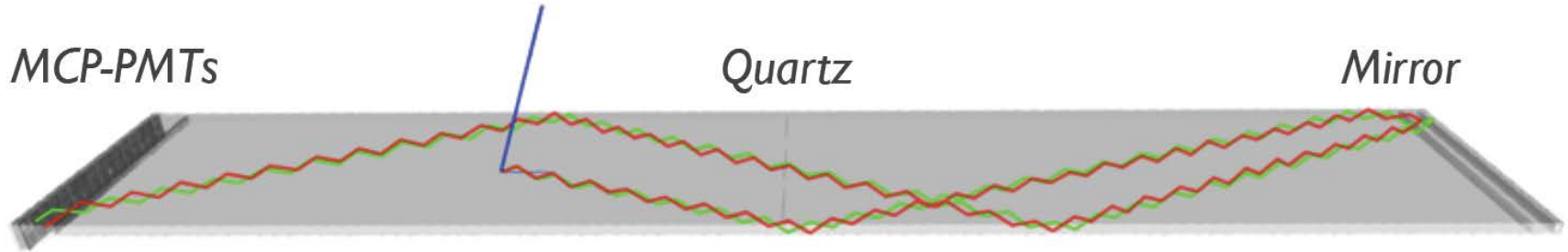

Example of Cherenkov-photon paths for 2 GeV/c π^\pm and K^\pm .

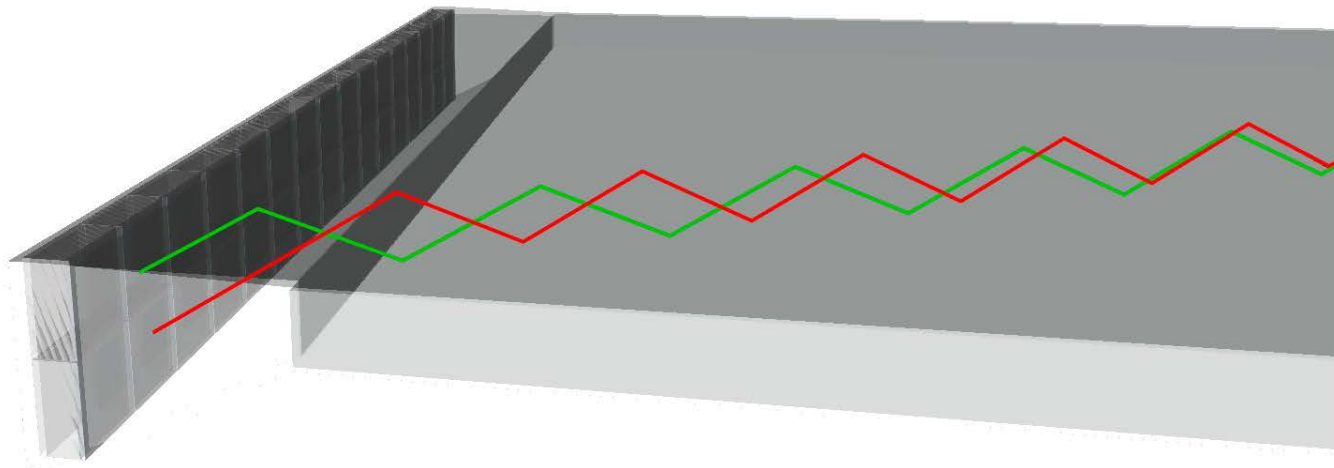

TOP image

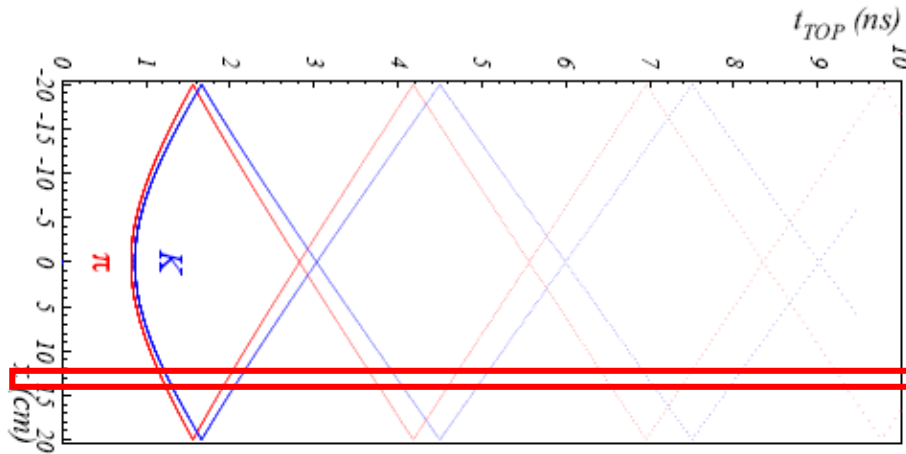

Pattern in the coordinate-time space ('ring') of a pion and kaon hitting a quartz bar

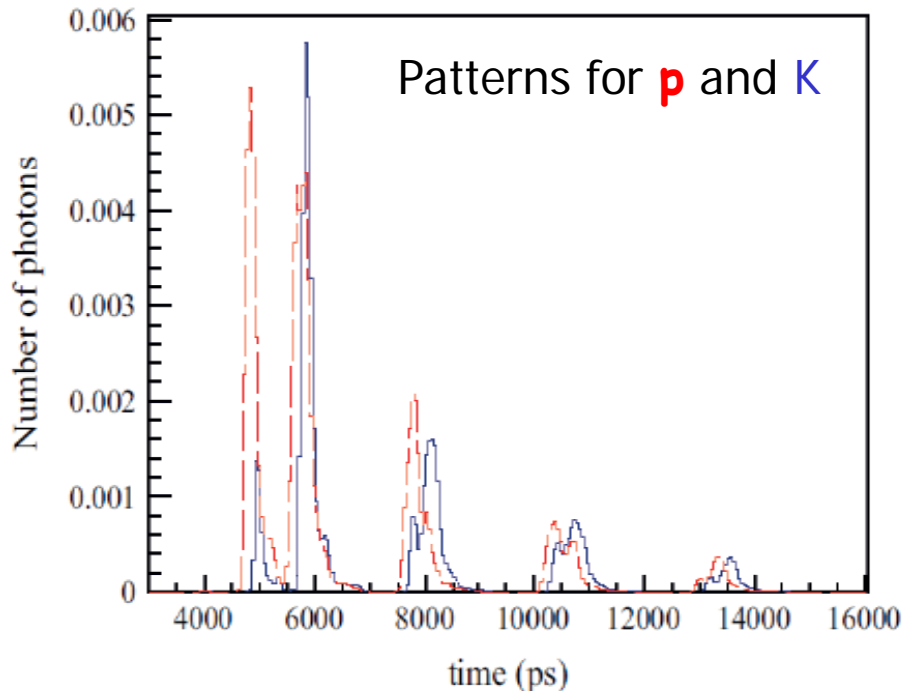

Time distribution of signals recorded by one of the PMT channels: different for π and K (~shifted in time)

EM calorimeter: upgrade needed because of higher rates (electronics \rightarrow waveform sampling) and radiation load (endcap, replace some fraction of crystals CsI(Tl) \rightarrow pure CsI)

EM Calorimeter:

CsI(Tl), waveform sampling (barrel)

Pure CsI + waveform sampling (end-caps)

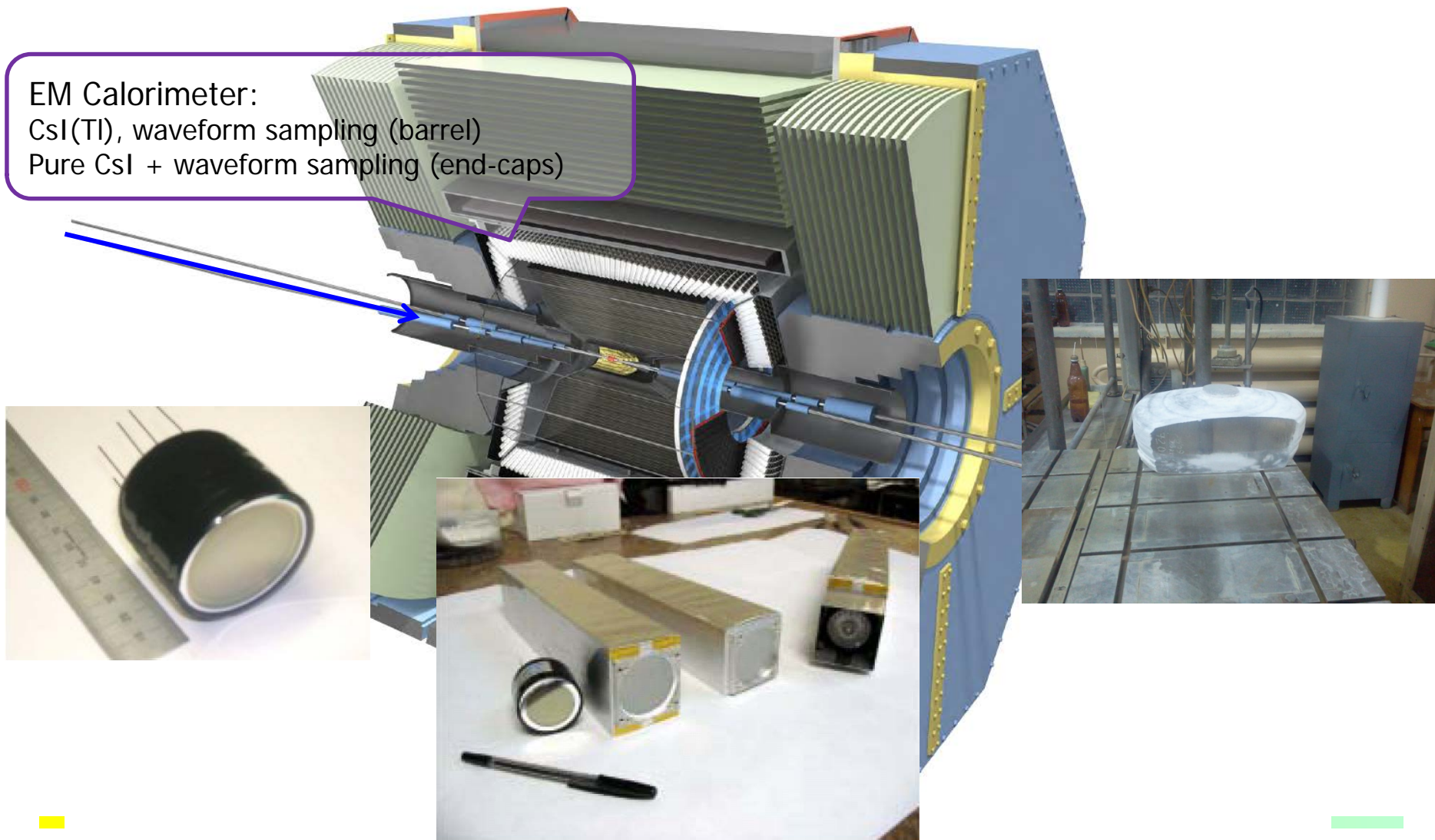

Detection of **muons and K_L s**: parts of the original RPC system have to be replaced because they could not handle the high background rates (mainly neutrons)

K_L and muon detector:
Resistive Plate Counter (barrel)
Scintillator + WLSF + MPPC (end-caps + barrel)

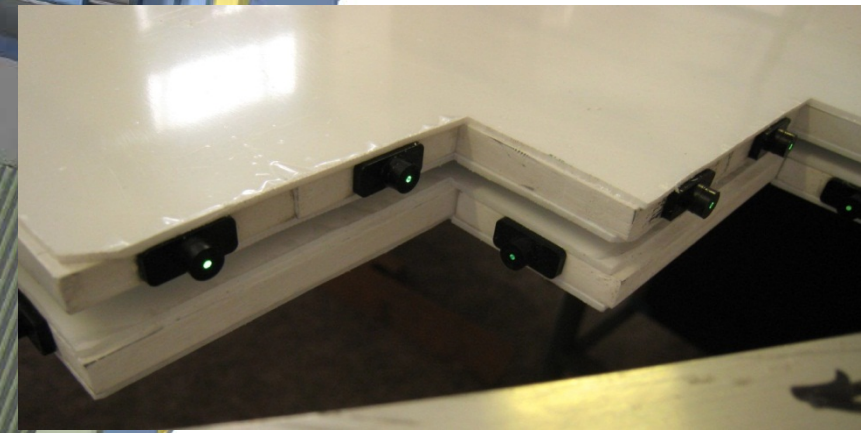
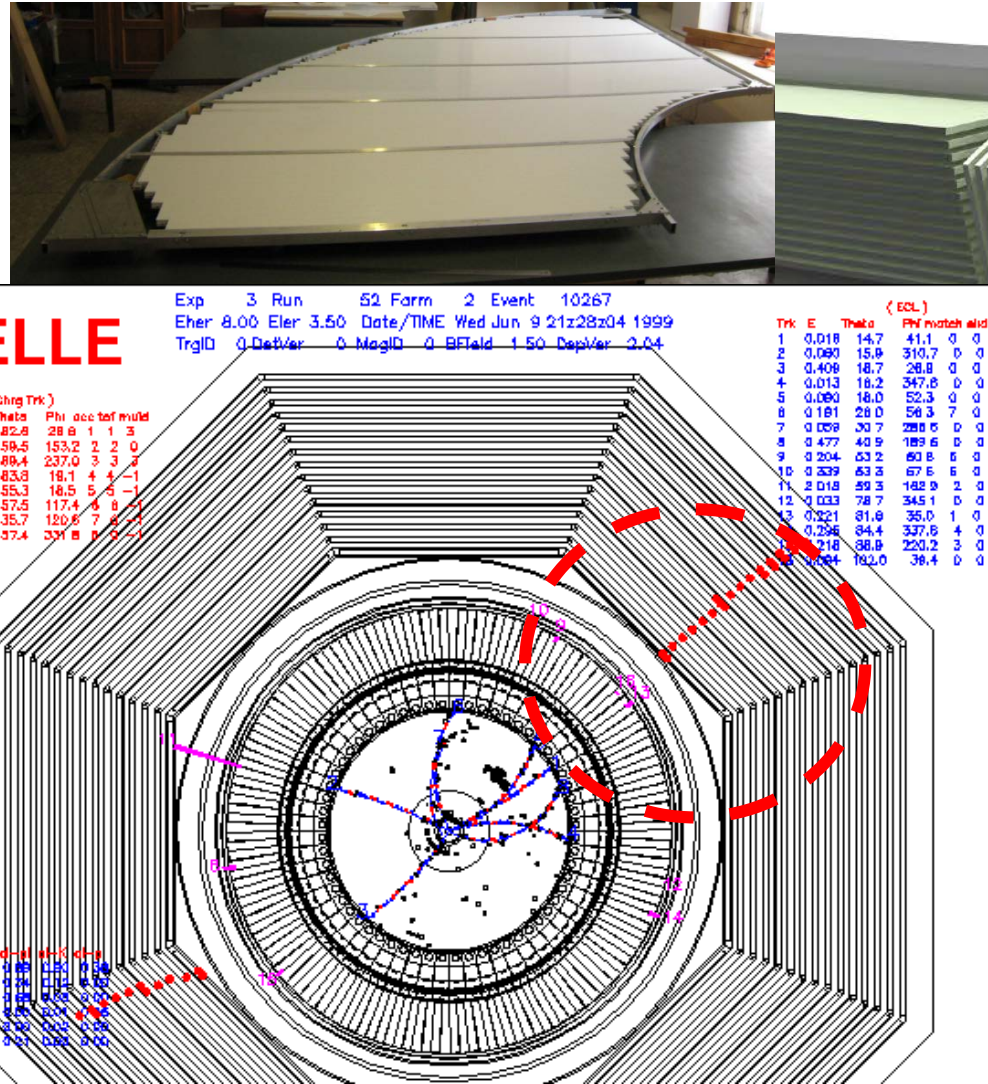
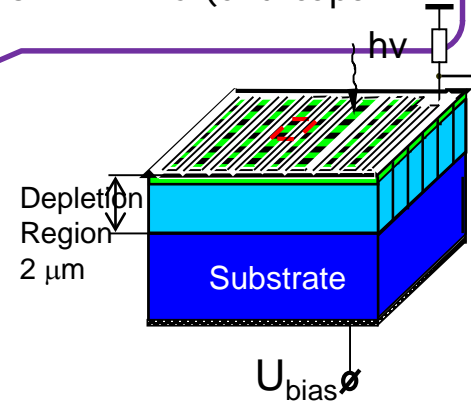

Muon detection system upgrade in the endcaps

Scintillator-based KLM (endcap in inner layers of the barrell part)

- Two independent (x and y) layers in one superlayer made of orthogonal strips with WLS read out
- Photo-detector = avalanche photodiode in Geiger mode (SiPM)
- ~120 strips in one 90° sector (max L=280cm, w=25mm)
- ~30000 read out channels
- Geometrical acceptance > 99%

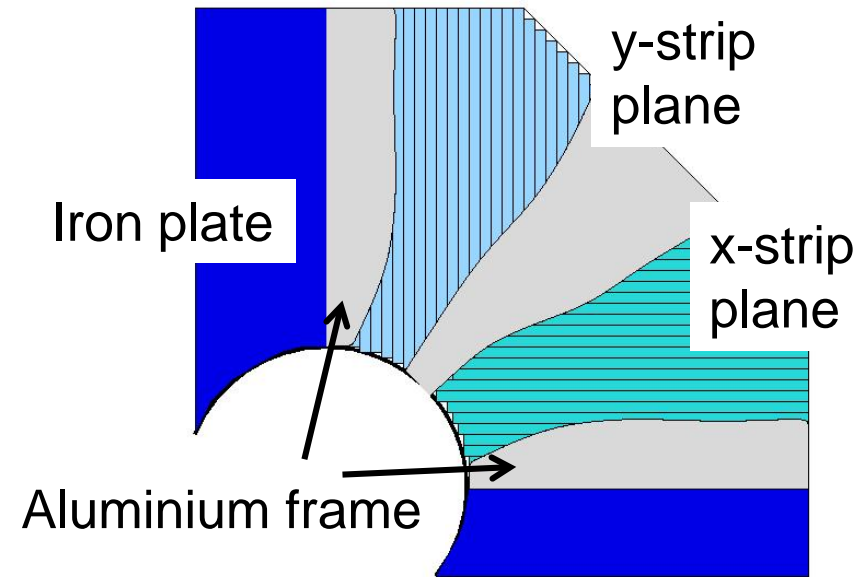

Mirror 3M (above groove & at fiber end)

Optical glue increase the light yield ~ 1.2-1.4)

WLS: Kurarai Y11 \varnothing 1.2 mm

GAPD

Diffusion reflector (TiO_2)

Strips: polystyrene with 1.5% PTP & 0.01% POPOP

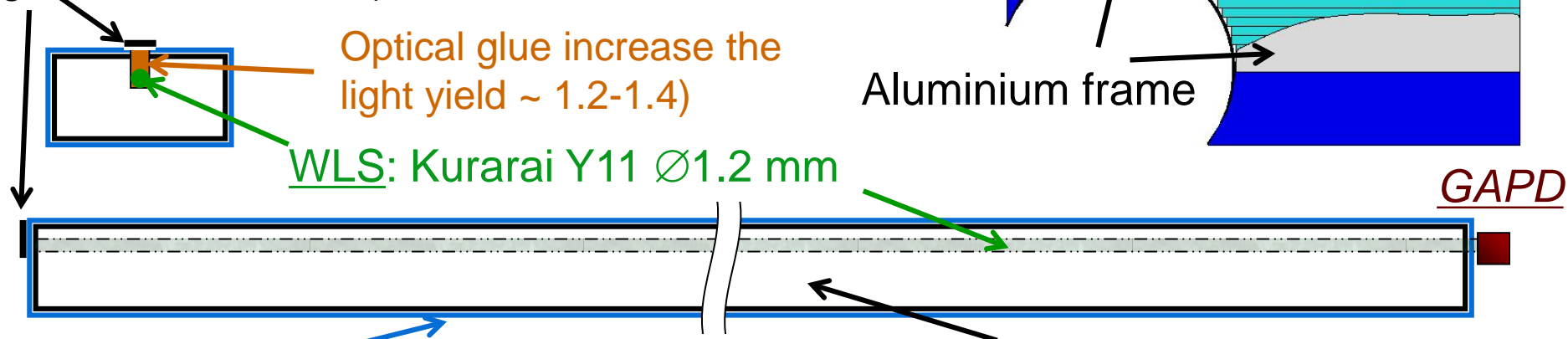

Outer Detector Highlights

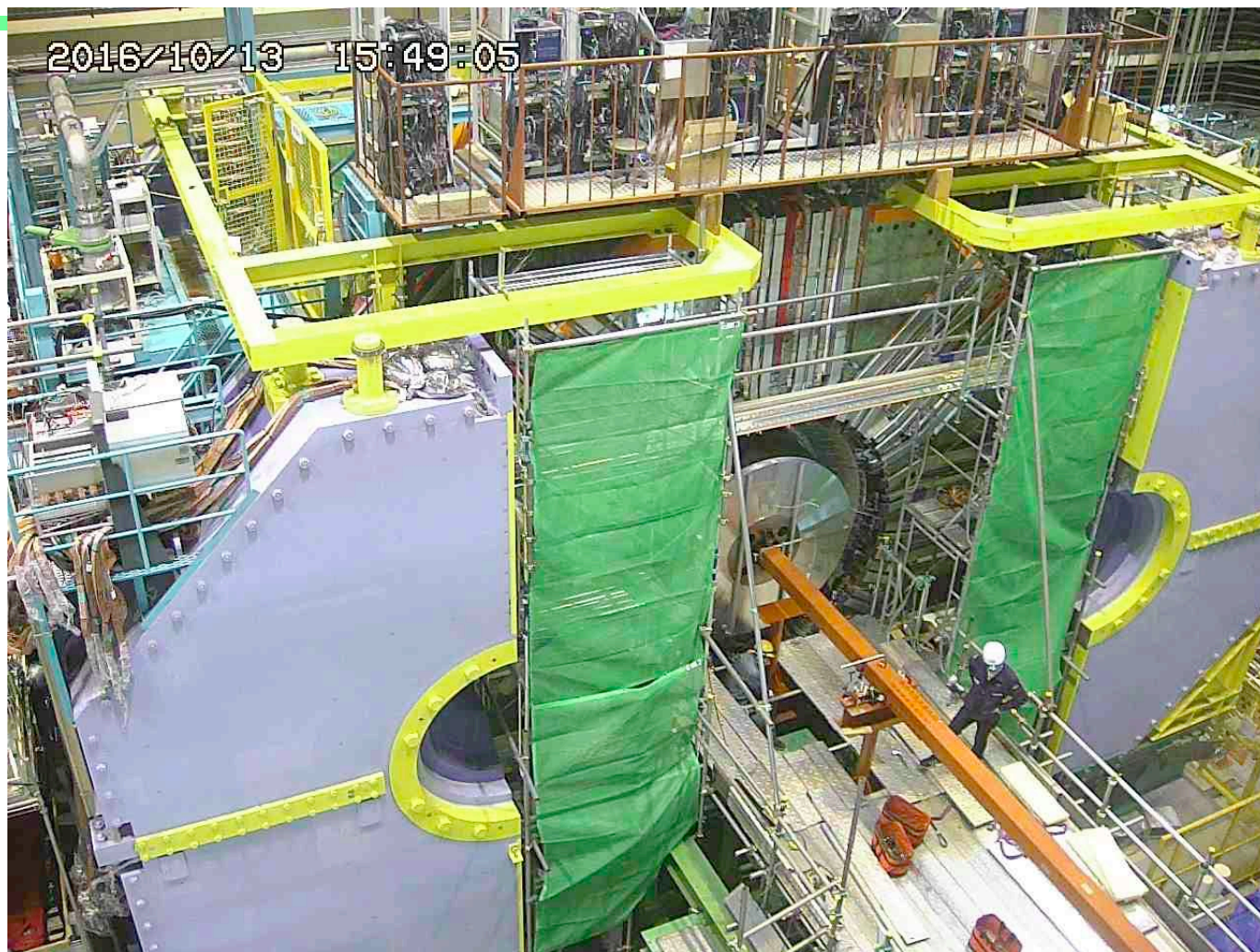

Magnetic field survey

Summary of the data

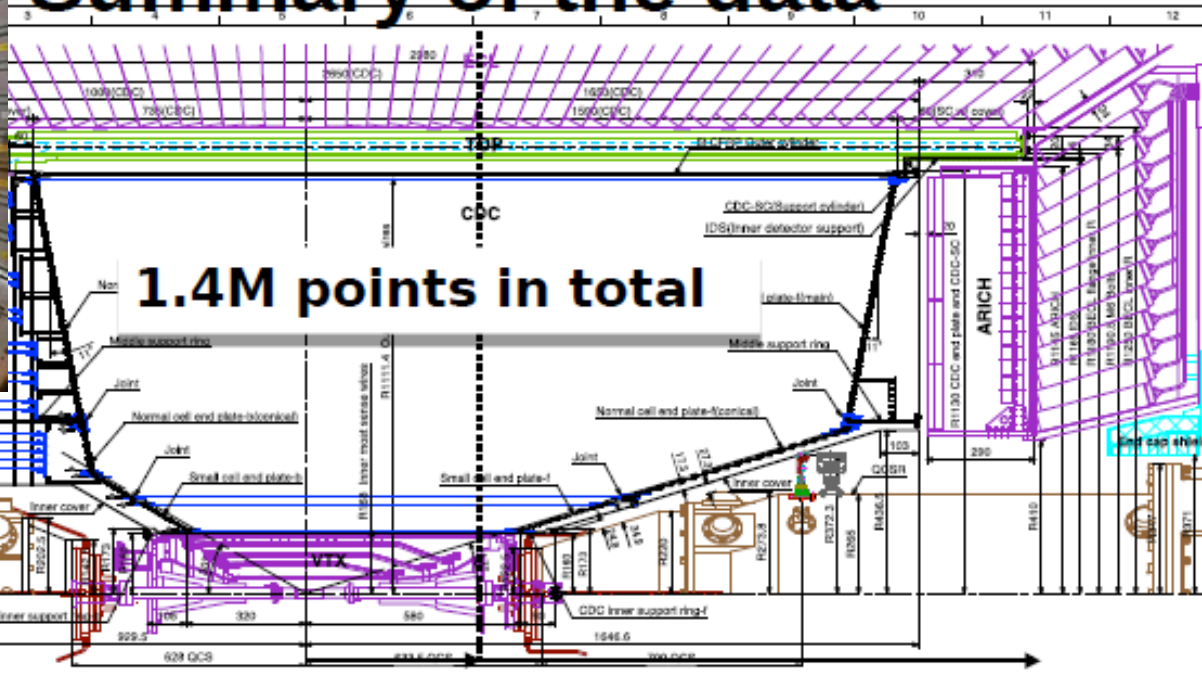

1.4M points in total

File index

Phi-step

Z step

| | | |
|-----|------|--------|
| 10: | 12: | 22 |
| 11: | 48: | 16 |
| 12: | 48: | 46, 16 |
| 13: | 48: | 28, 16 |
| 14: | 48: | 79 |
| 15: | 48: | 38 |
| 16: | 48: | 38 |
| 17: | 48: | 92 |
| 18: | 48: | 46 |
| 19: | 48: | 46 |
| 20: | 180: | 8 |
| 21: | 48: | 91 |
| 22: | 96: | 40 |
| 23: | 96: | 40 |
| 24: | 60: | 67 |

27-28 June

1-3 July

1.50 T
1.25 T
1.00 T

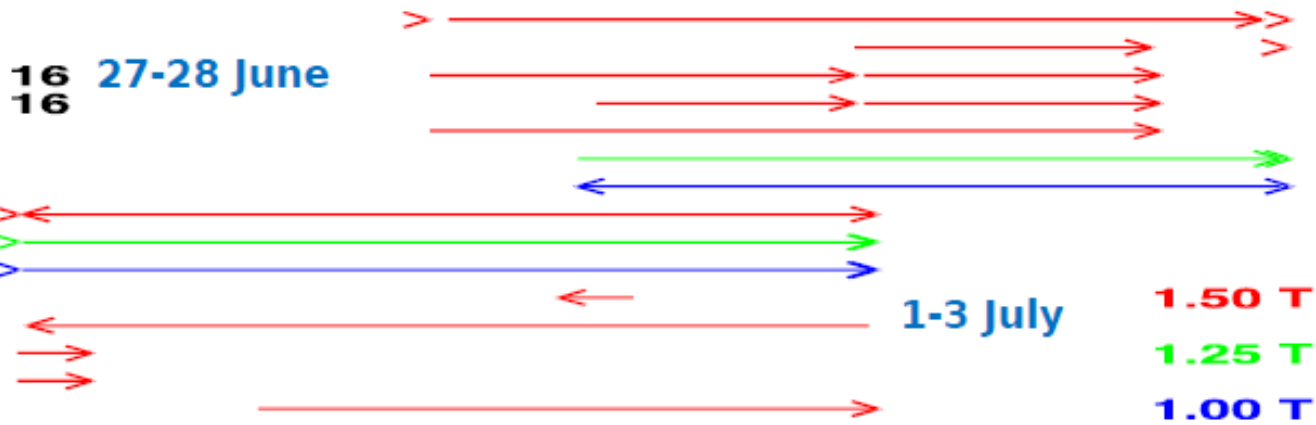

CDC, stand-alone cosmic test in spring

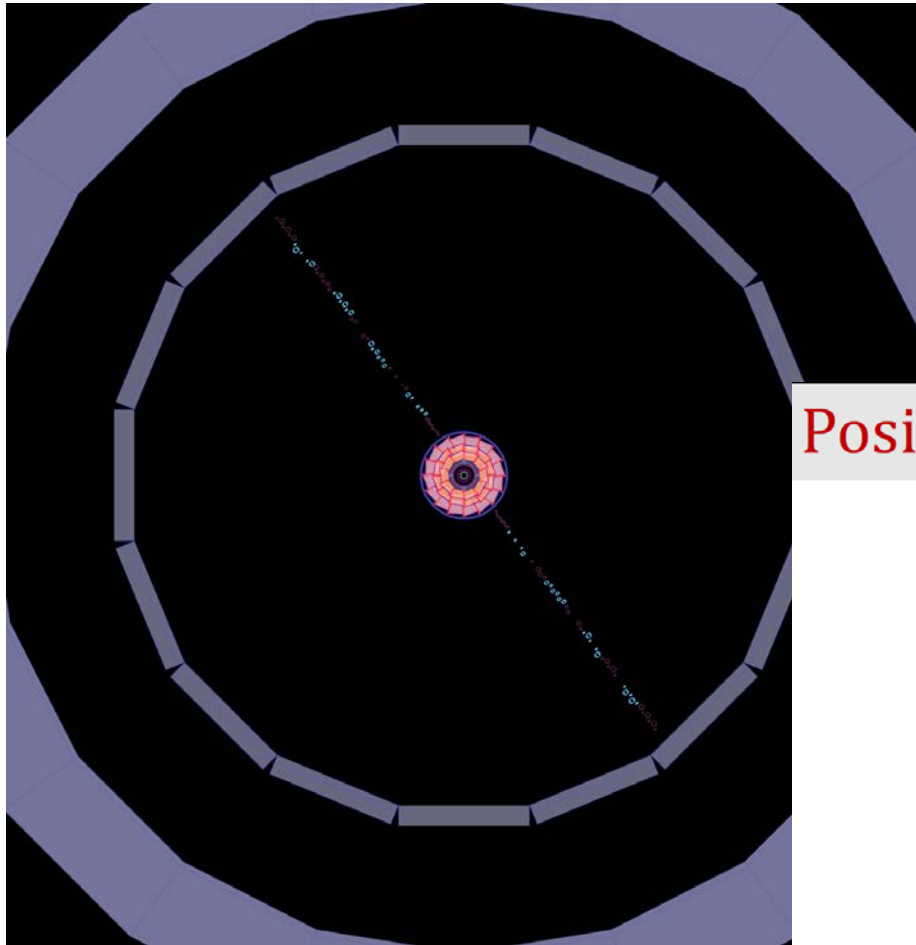

Excellent performance!

Position resolution

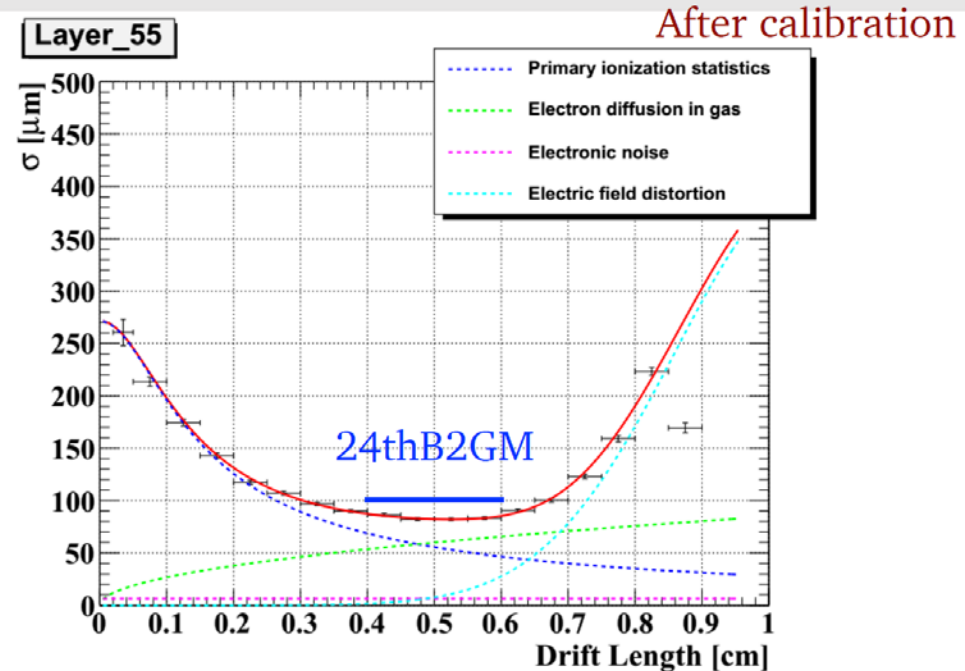

Position resolution at good region: 80-150 μm , it depends on layer.

Before installation: CDC cosmic ray test

- A cosmic ray test was performed in the back-to-back configuration using 59 (out of 299) FE boards.
- Clear tracks were observed using the real Belle-II central DAQ system.

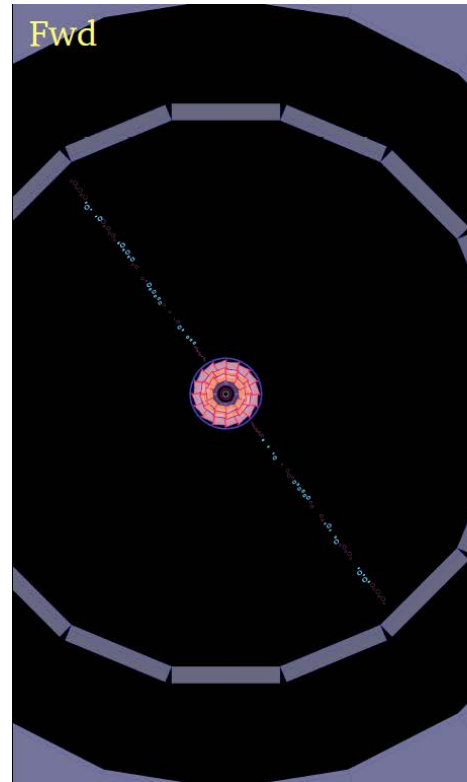

Event display

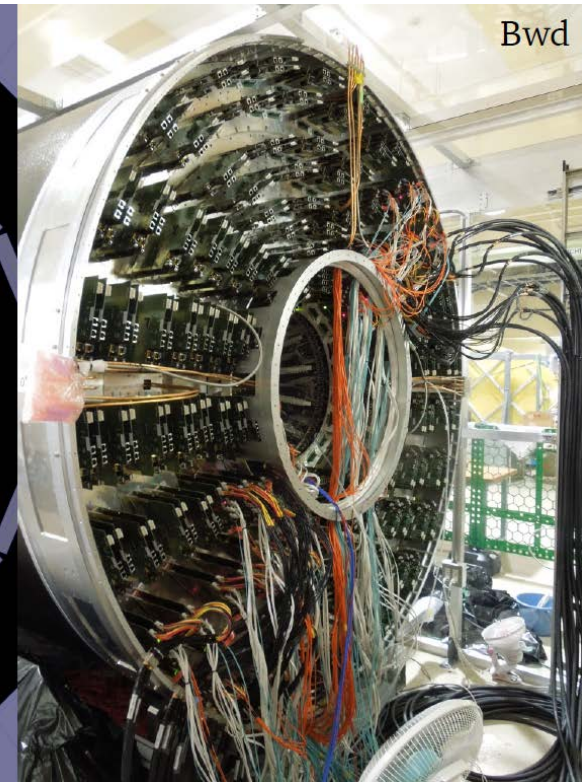
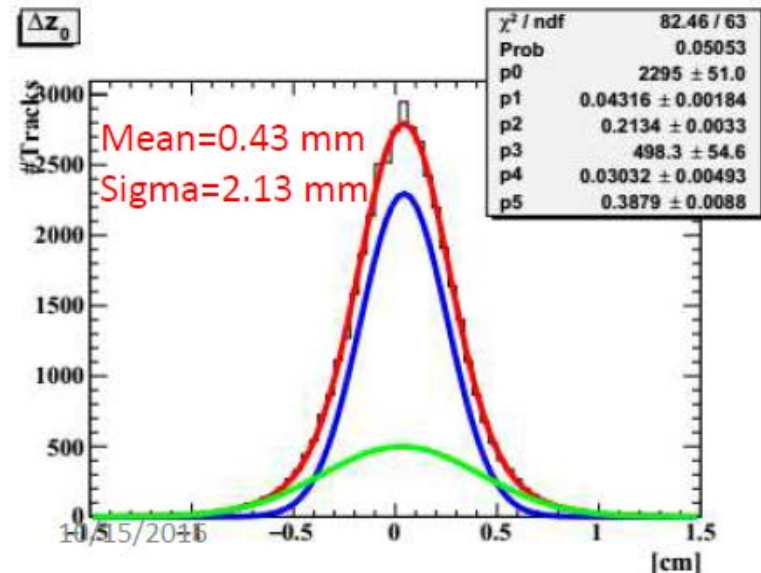
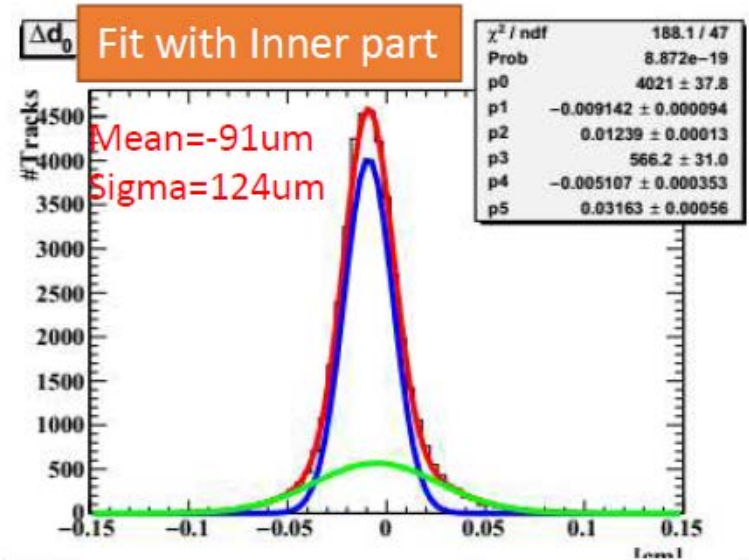

Photo in the side room
with many cables

Analysis of CDC cosmic ray muons

- Upper and lower track segments were analyzed separately.
- Reasonable matching resolutions were already obtained between two tracks in both $r-\phi$ and z directions even at this initial stage.
- A *small* systematic shift in $r-\phi$ is found due to a tiny rotation of the inner CDC with respect to main part of the chamber.



TOP and CDC: installed, cabling of CDC almost finished

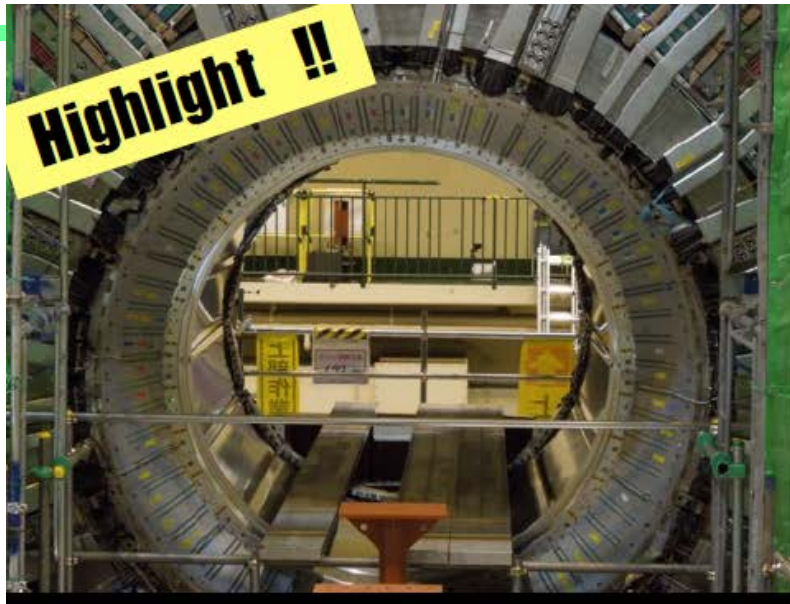

Futaba company
and T. Kohriki(KEK)

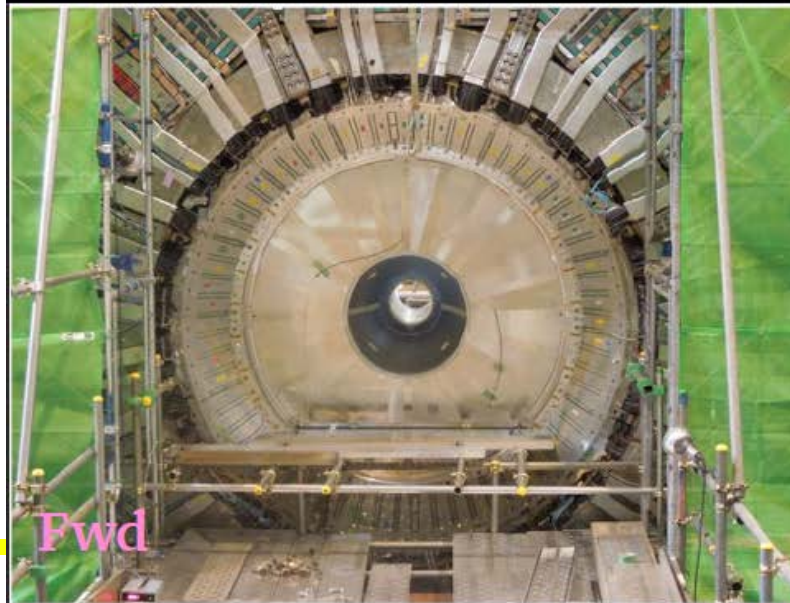

TOP: running the installed detector

- High statistics laser/cosmic running for all modules with stable ASIC configuration completed
 - Both with and without B-field to understand performance differences
- Significant progress on firmware, but feature extraction not yet implemented on installed modules due to urgent need for stable operation
- Gain operational experience in 1.5 T B-field !
 - Serious issue with PMTs discovered (“rotation issue”)
 - MCPs use Kovar (Cobalt-Nickel alloy) and are magnetic.
 - Repair to main issue completed

MCP-PMT Rotation Problem

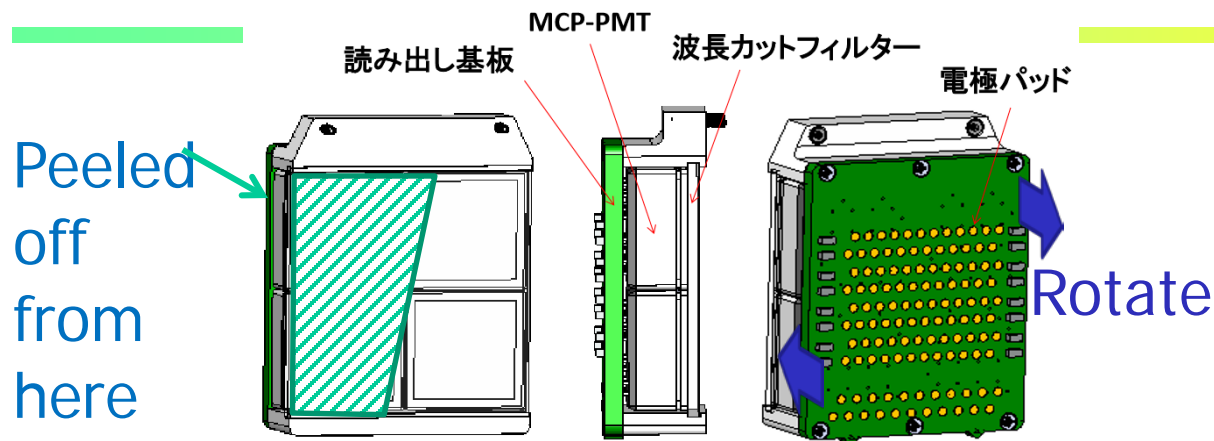

- ▶ Repaired all 16 modules and retested in B-field prior to CDC installation
 - Shim between PMT modules and aluminum enclosure on side that wants to move towards the prism to restrict rotation
- ▶ New problem of individual PMTs moving found in 2 MCPPMT modules
 - Fixed these and decided to install CDC and observe TOP until Phase II-III shutdown

Slot07 PMTmodule07



The bottom two PMTs rotated and came off the filter.

Slot11 PMTmodule02

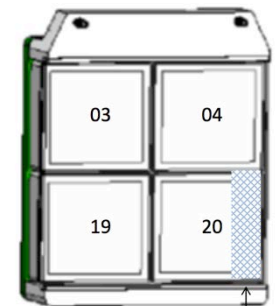

This part came off the filter.

ARICH: Rings from cosmic ray muons

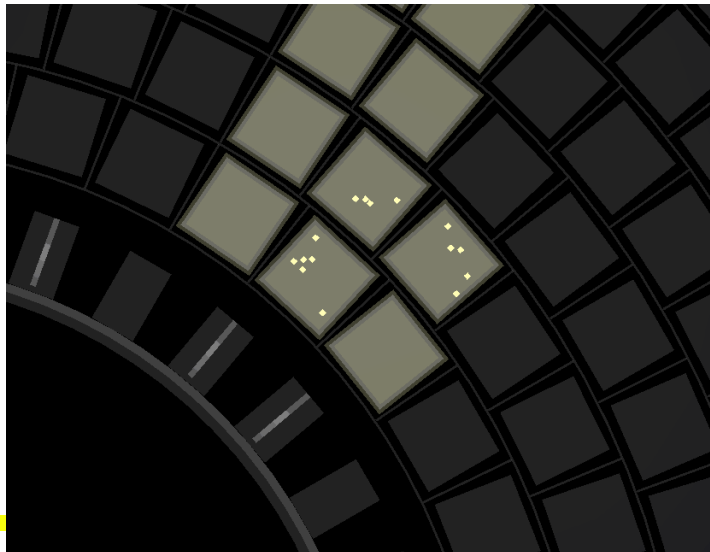
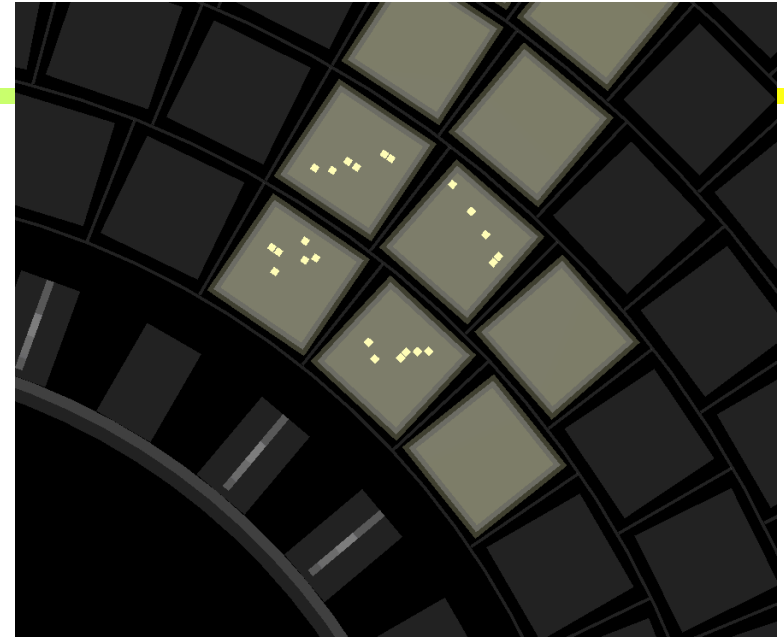
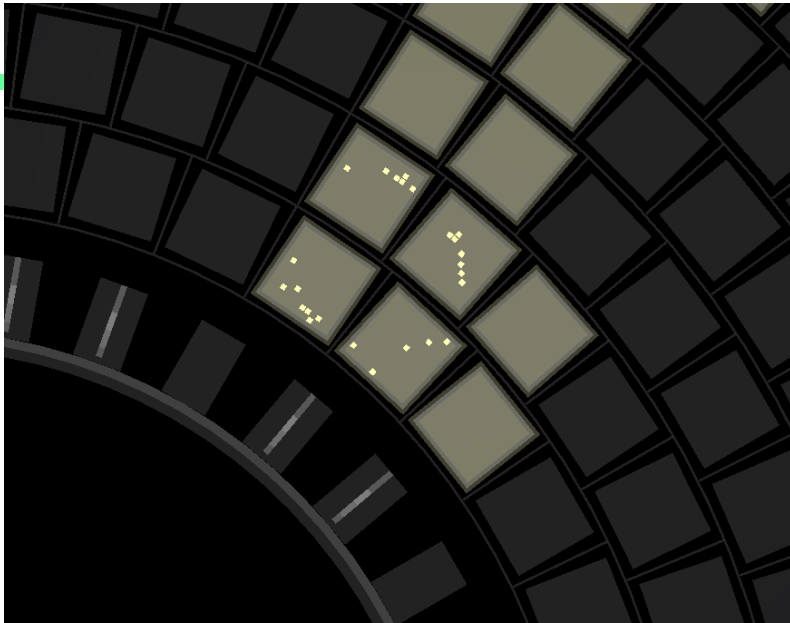

One sector of the ARICH has been instrumented.

ARICH Highlights

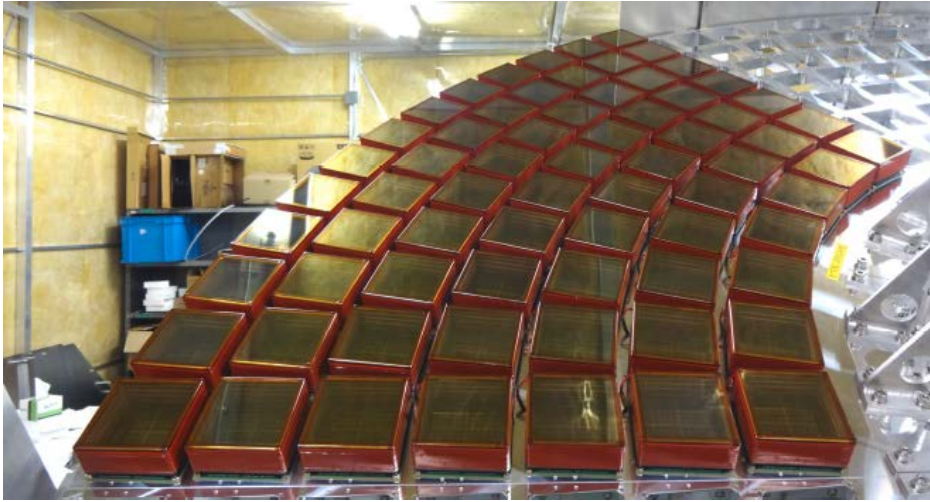

- First rings observed in August
 - We are expanding our cosmic test setup for more HAPDs.
 - We expect to complete the detector in Mar. 2017. After the system test, ARICH will be ready to connect with forward endcap in May 2017.
-
- Aerogel installation will be finished in Nov.
 - Photosensor (HAPD) delivery will be completed by the end of the year.
 - HV connectors and cables are critical for ARICH construction schedule.
 - ✓ We plan to finish the test with of cables HAPDs in Oct., and we want to move to mass production immediately after that.

The magnetic torque on HAPDs seems to have only a small impact. Probably this is not an issue, though additional test are planned. Measurements in excellent agreement with calculations.

ECL Highlights

ECL Trigger is now available

Shape of the signal from each of 6624 barrel counter was calibrated

Accuracy of shape description is 10^{-3}

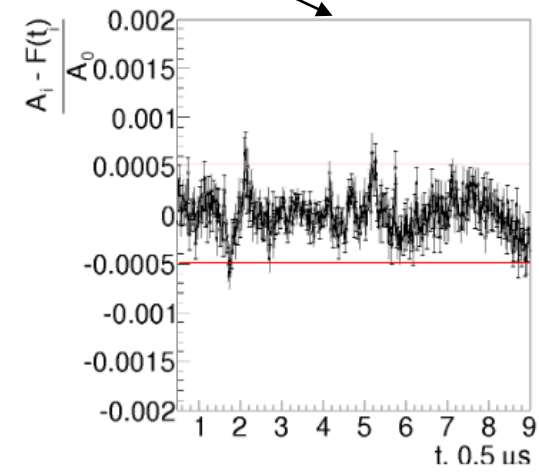
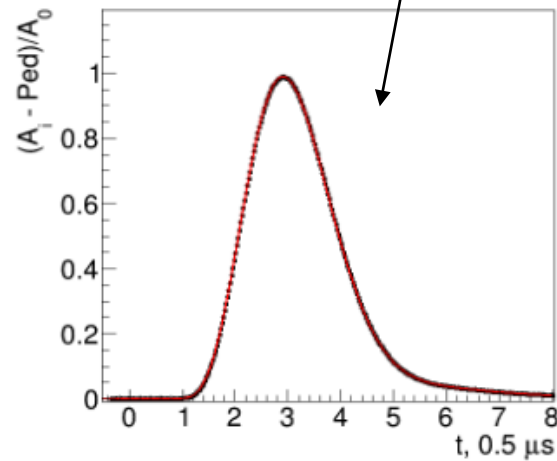
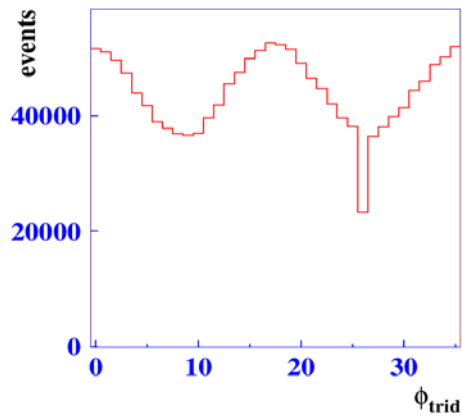
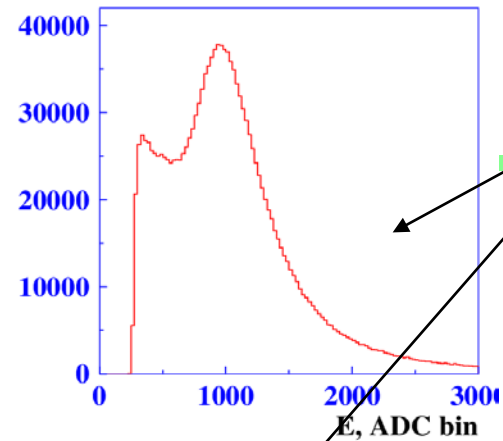

• Firmware modifications for Shaper DSP were implemented:

-test pulse time stability

-uploading of shaperDSP from optical link

All Backward KLM sectors fully connected to DAQ boards and tested

EKLM

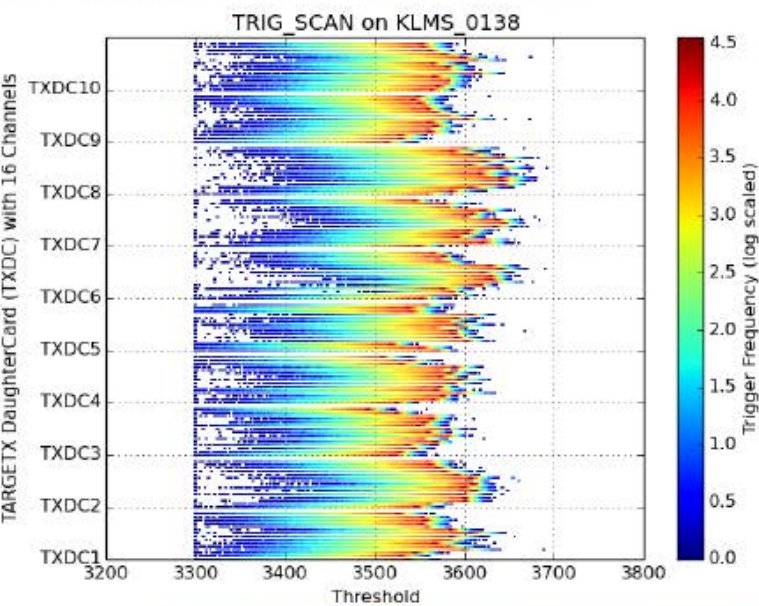

Test of one superlayer, 150 channels

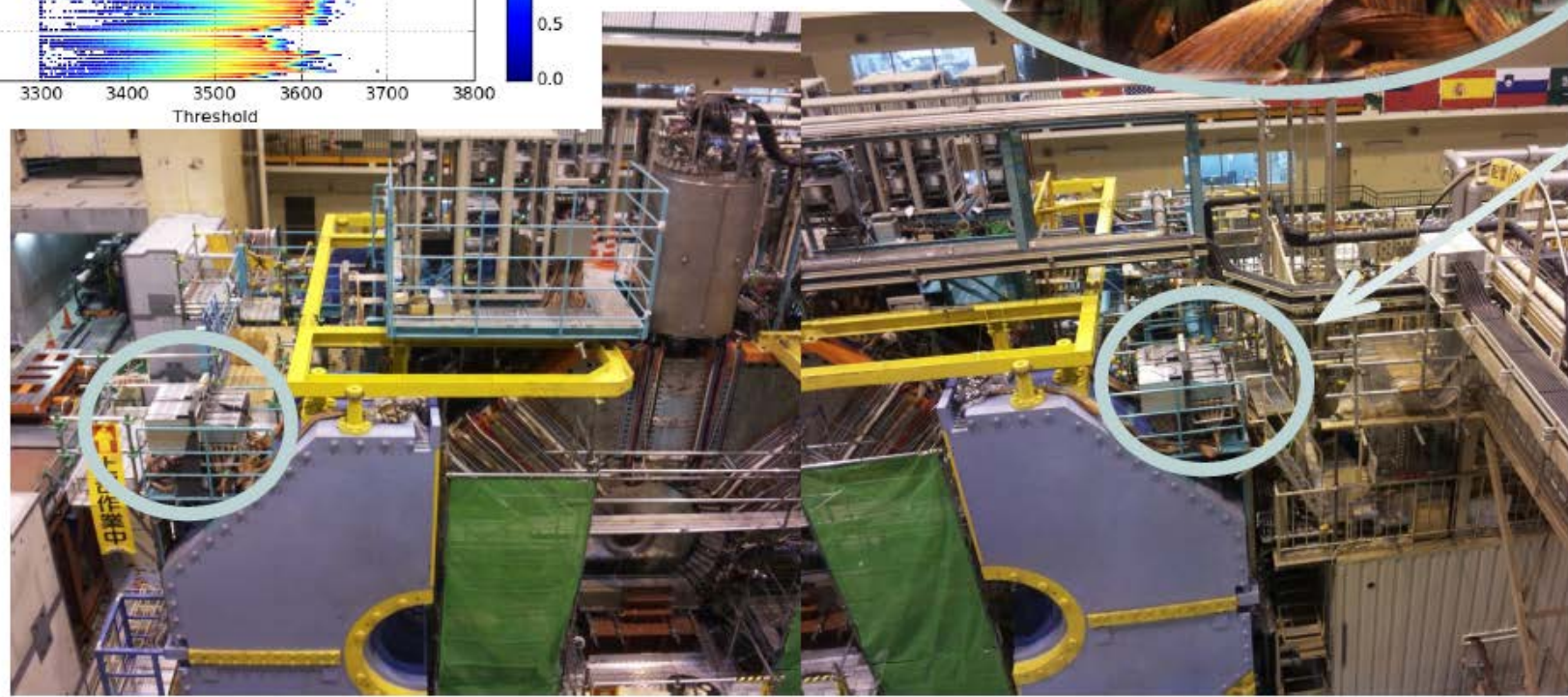

Forward KLM sectors: 30% done, complete connection by the end of this year

BKLM Highlights

- ✓ All DAQ infrastructure (scintillator readout modules, data concentrators, cables/fibers, FTSWs, COPPERs, UT3 trigger) installed
- ✓ Forward octants BF0–BF7 operational (*taking data, sending to backend*) →
- ✓ UT3 trigger for KLM-TOP is operational
- ✓ INFN contracts awarded for production of 250 RPC readout boards: completion 7/17

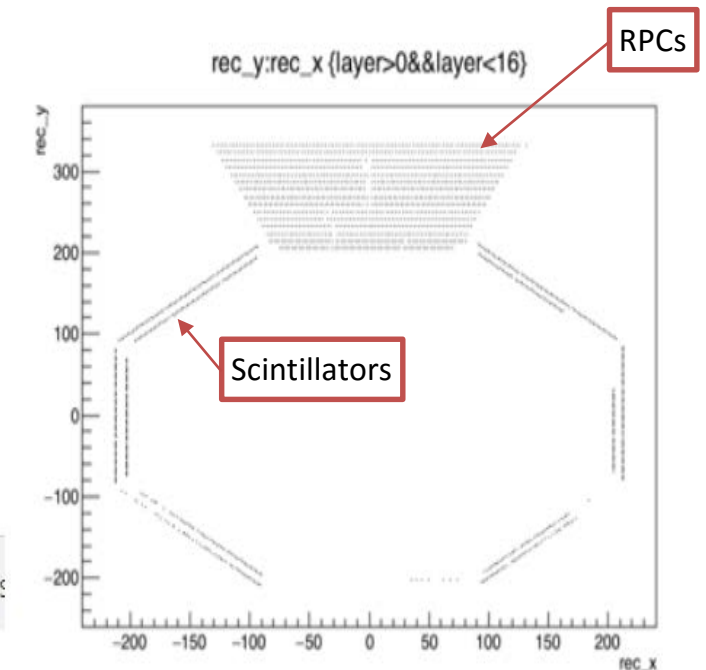
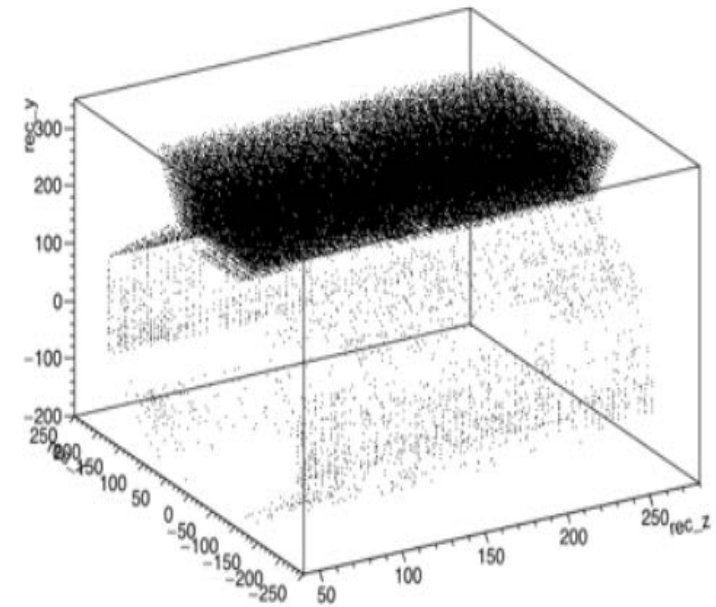
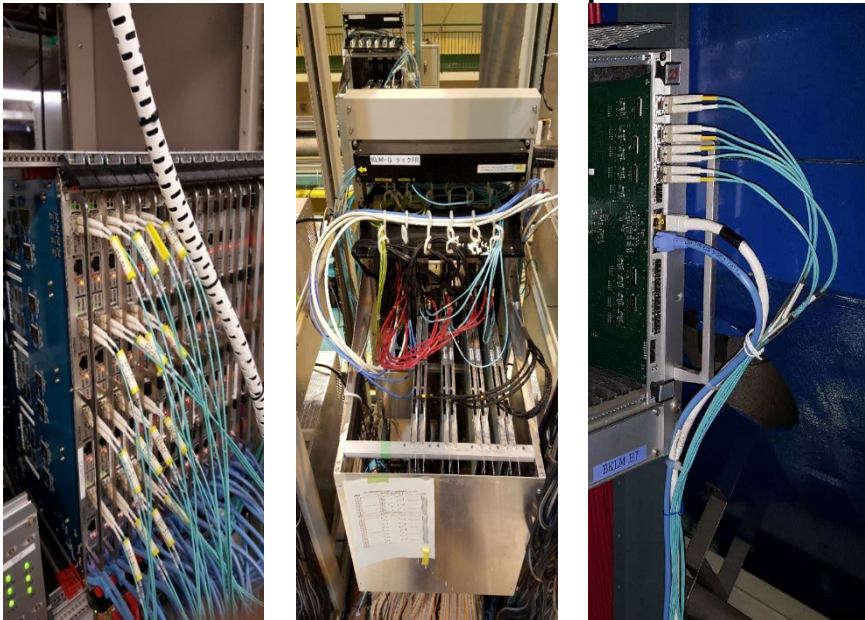

Global DAQ: 2D hits in BKLM Forward octants

PXD Ladder Production

2-layer PXD

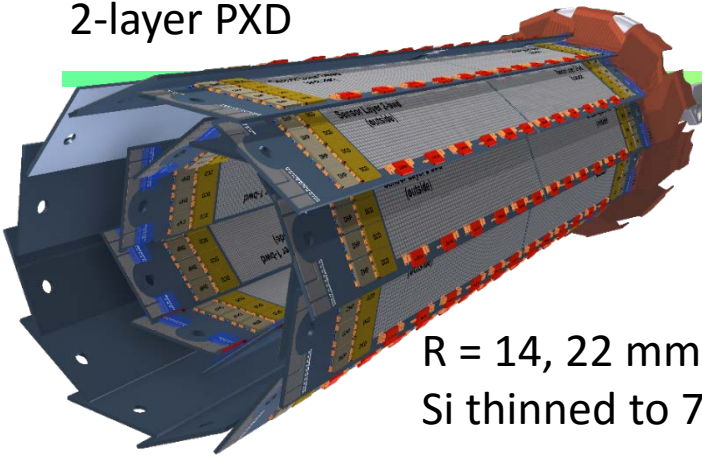

R = 14, 22 mm
Si thinned to 75 μm

8 (L1) / 12 (L2) self-supporting ladders:
2 modules glued end-to-end, mounted
on SCB (= support and cooling block)

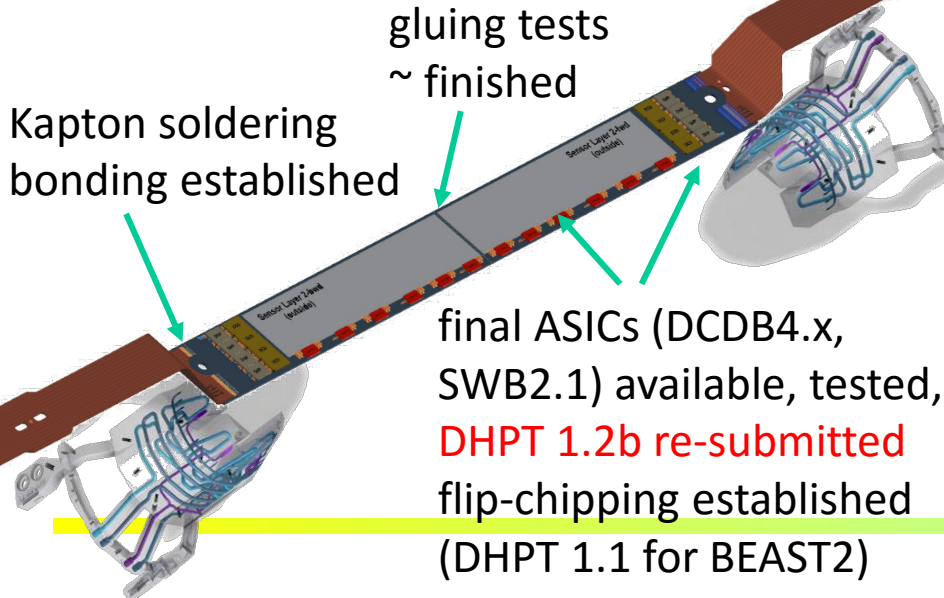

Total of 29 wafers in process (172 sensors, 40 needed)
Combined yield Pilot (3) + PXD9-7 (4) + PXD9-8 (5 sensors):

- 74/96 (87.5%) working sensors (>97.5% pixels)
- 64/96 (66.7%) prime grade sensors (>99% pixels)
- Production yield better than expected (> 50%)

Main prod. 1 (PXD9-8): 9 wafers (5 ready)
Main prod. 2 (PXD9-9): 6 wafers (= metalliz.)
entire production finished by Dec. 2016
Contingency: 7 wafers (Phase II: metal 1)

We have already now all PXD sensors needed for the Phases 2 and 3 PXD („contingency“ production continues)

Bottleneck right now: bumping of SWB2.1 (comes as single chip from MPW run), *develop new process* with IZM Berlin in (wafer) matrix, first results next month

Module production for BEAST2 started (flip-chipping at IZM, back in 3 weeks)

PERSY (Permanent System @ DESY) → BEAST2 → PXD

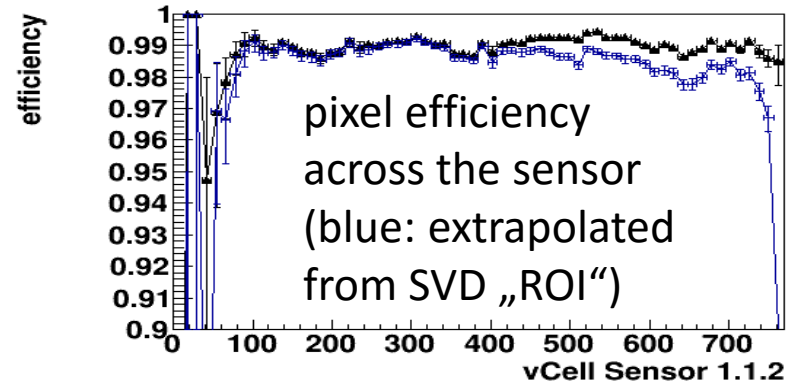
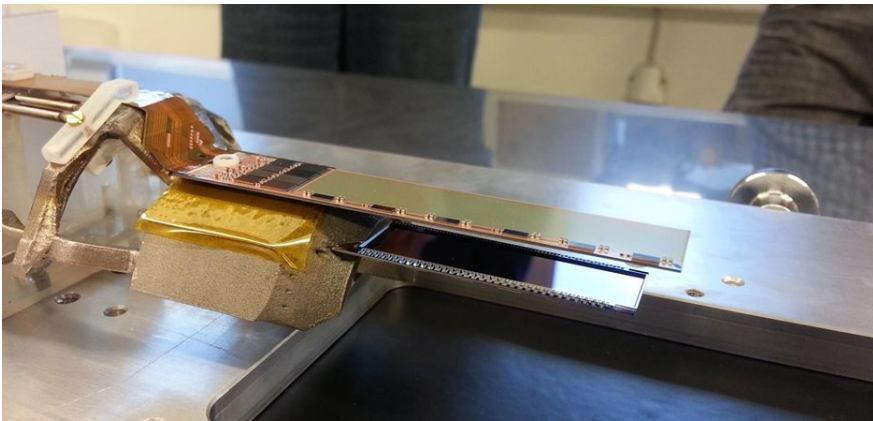

The start: 2 PXD modules with ASICs, SMDs and Kapton, fixed on and cooled by SCB (April, 16)

Aim: stepwise system integration including DHH / Onsen / pocket DAQ

Present status (fall 2016): Problems during DESY test beam (April 2016) solved (ROI crisis, event number mismatch)

Next step (Dec `16 – Feb `17). Build Phase 2 detector system: PXD + SVD + FANGS/CLAWS/Plume

full DAQ:

- Dec. `16

final beam test:

- Feb `17

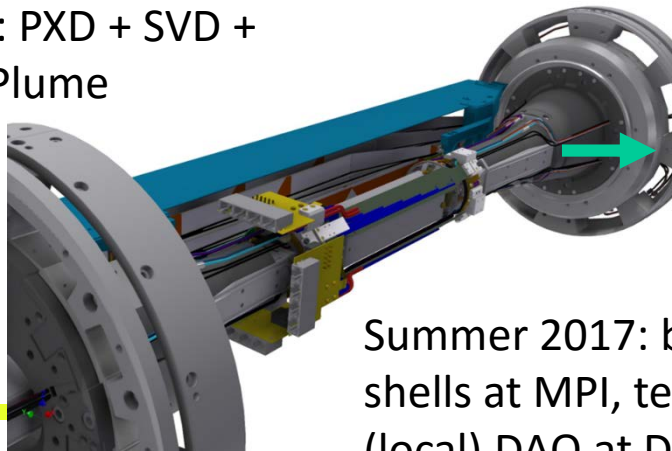

Summer 2017: build half shells at MPI, test with (local) DAQ at DESY

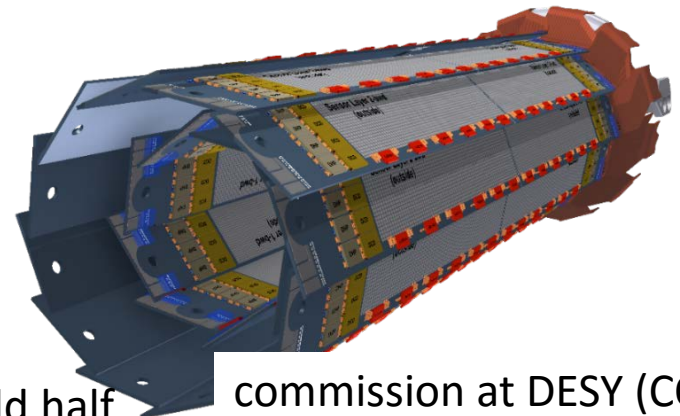

commission at DESY (CO₂ / cosmics), transport to KEK by early spring `18

VXD (= PXD + SVD) Interaction Region Components

2-phase CO₂ cooling unit („IBBelle“)

built at MPI in collaboration with
CERN / Nikhef (~same as ATLAS unit)

Cooling power > 2 kW fully commissioned
at MPI (needed for PXD/SVD : 360/750 W)

IBBelle has arrived at KEK on Oct. 20



VXD thermal management mockup for CO₂
cooling studies: original sizes and materials

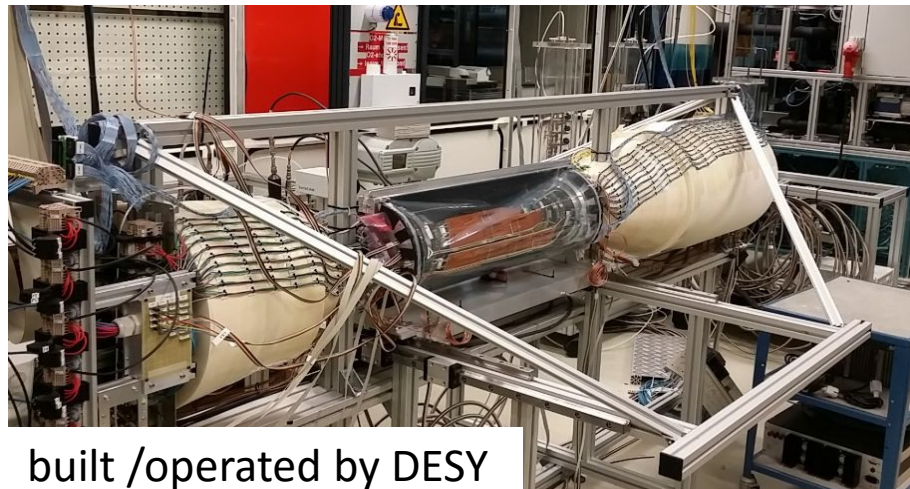

built /operated by DESY

VXD installation into Belle (design by MPI)

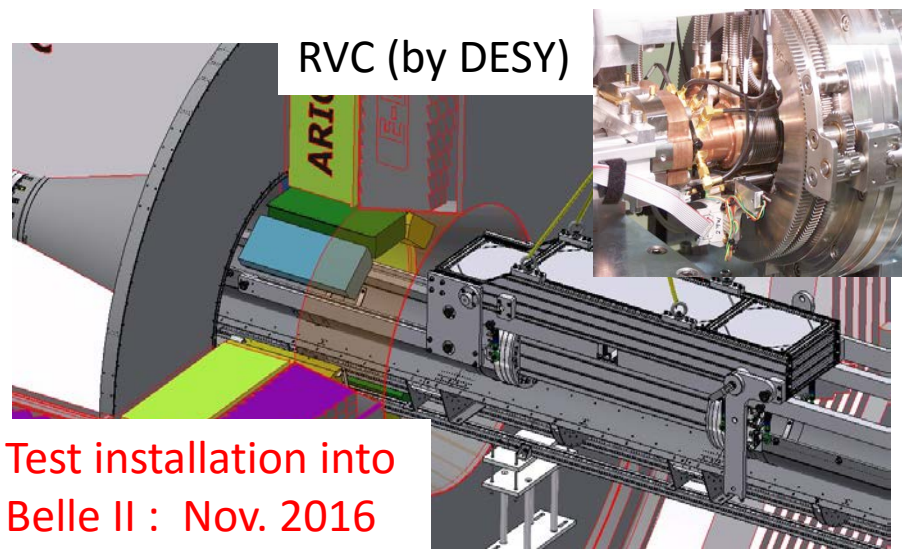

Test installation into
Belle II : Nov. 2016

SVD ladder production status

- [Pisa \(FW/BW\)](#) Production of the nominal 47 forward and backward sub-assemblies completed by October 7, 2016
- [Melbourne \(L3 \)](#) 9 out of 7+2 ladders completed by October 11, 2016
- [TIFR \(L4 \)](#) 4 out of 10+2 ladders completed, assembly of the 5th class A ladder ongoing
- [HEPHY \(L5 \)](#) 4 out of 12+3 ladders completed, assembly of the 5th class A ladder ongoing
- [Kavli IPMU \(L6 \)](#) 3 out of 16+4 ladders completed, assembly of the 4th class A ladder ongoing; 7 working day/week assembly shift system is being set up, which will allow L6 to meet the global schedule.

Trigger, DAQ and readout integration

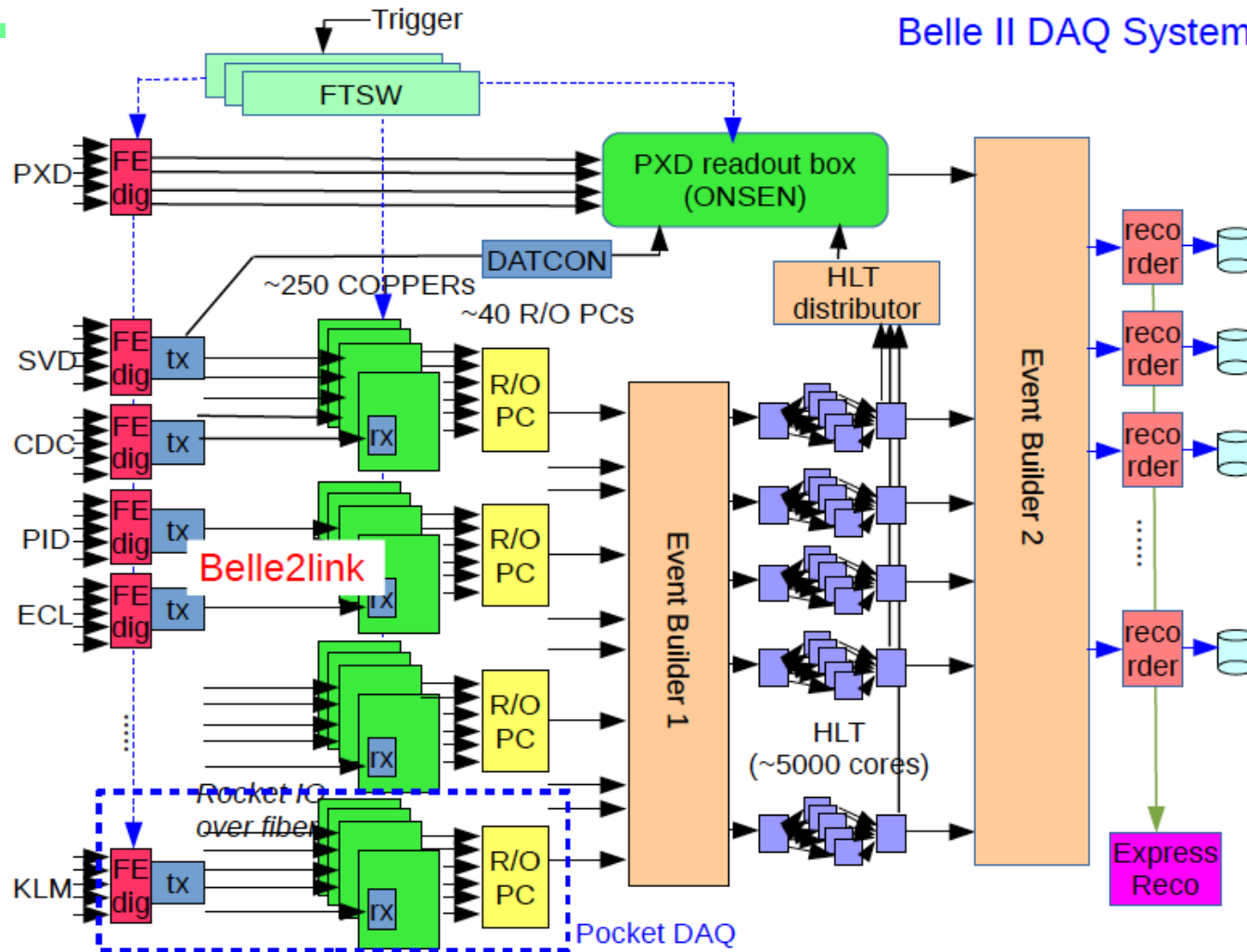

Readout Readiness Review by the BPAC on the weekend

SuperKEKB/Belle II Status

- **Commissioning** (Phase 1) of the main ring (without final quads) successfully carried out from Feb 1, 2016 – end of June! Interaction point detector: instead of Belle II, a commissioning detector – **Beast II**.

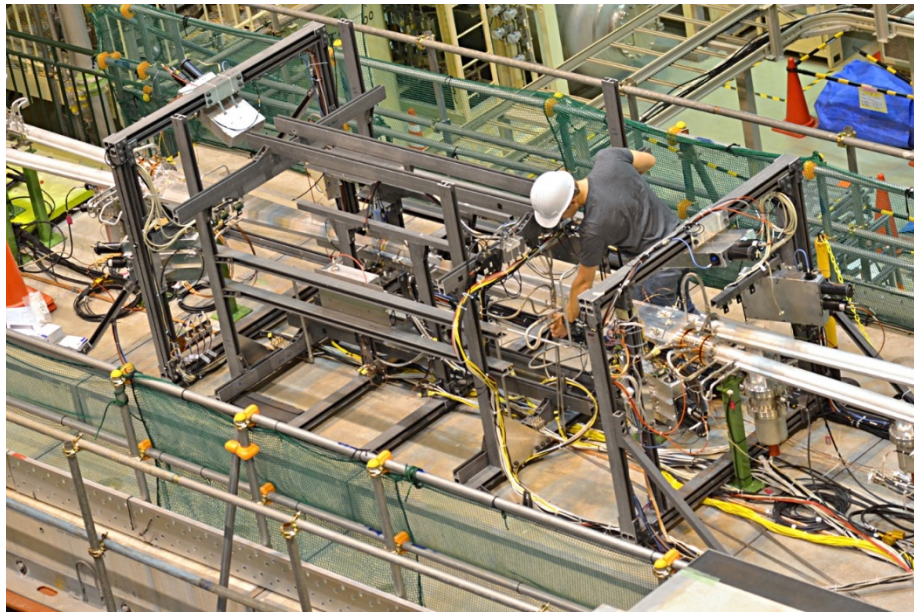

BEAST II: First experience with the new accelerator complex (no QCS)

HER integrated beam dose 662 Ah (LER 776 Ah)

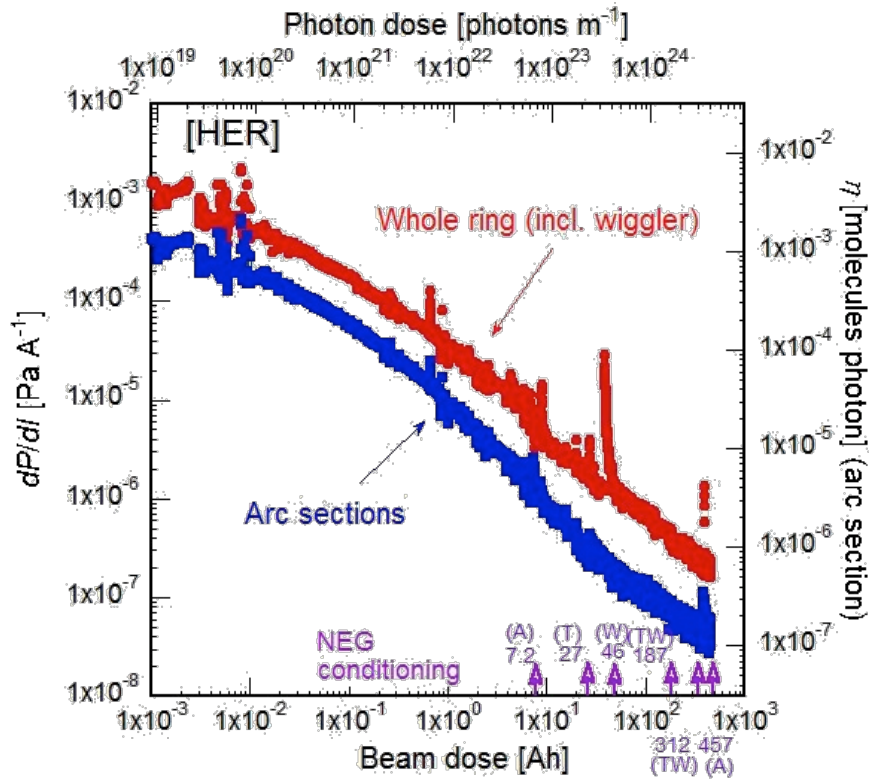

BEAST background in the HER vs time

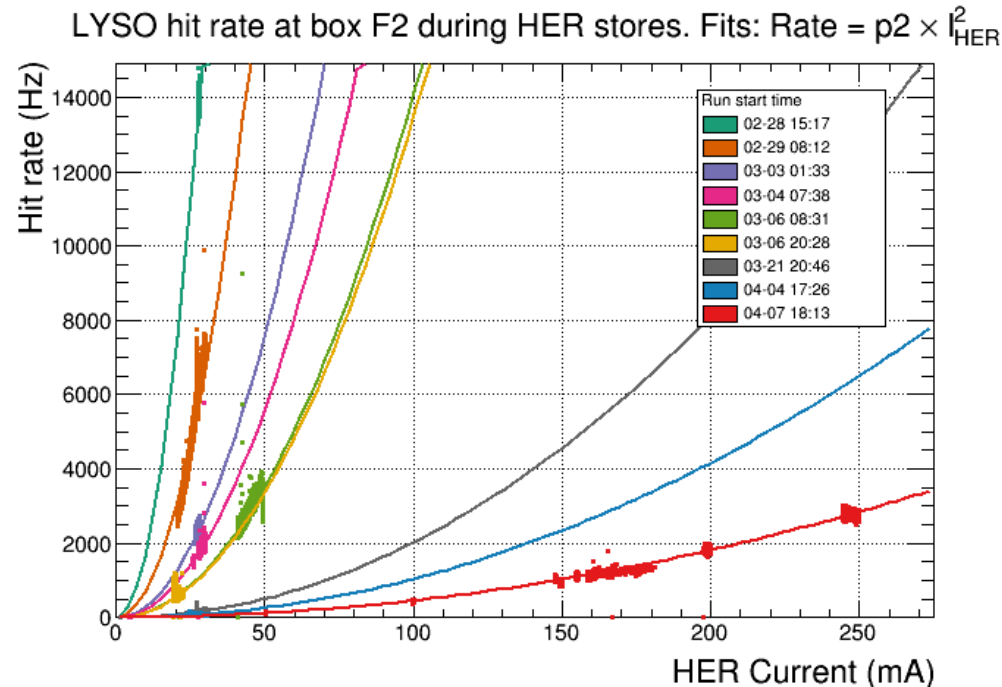

BEAST II, Phase 1: Many New Results

Example: Touschek LER study

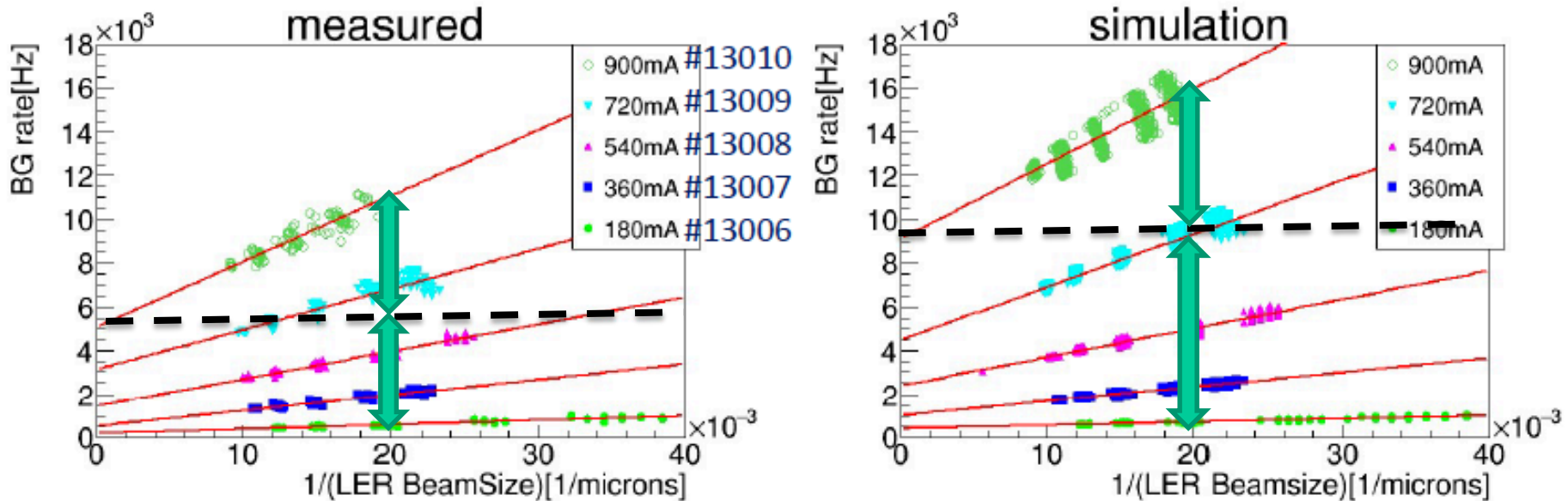

- At 900 mA
 - LER beam gas rate: MC / data ~ 1.8
 - LER Touschek rate: MC / data ~ 1.2
- But
 - BeamSize from x-ray monitor still needs to be corrected
 - Sensor position in MC not fully accurate

Precision MC/data comparison still ongoing. Aiming to have publication ready for collaboration review in spring 2017.

BEAST Phase 1: Lessons Learned

- Vacuum scrubbing successful, but not complete
 - Dynamic pressure low, but not at design value
- Safe to install Belle II + BEAST phase 2
 - Total dose in phase 1: A few hundred krad near beampipe
 - $\sim 1/r^2$
 - No large dose from SR
- LER Beam gas and Touschek BG agree roughly with predictions
- HER Touschek BG does not agree with predictions
 - More work needed to understand
- SAD modifications resulting from phase 1 validation led to increase in predicted HER Touschek BG for phase 3
 - may still be mitigated by collimators

2016-2017 Schedule

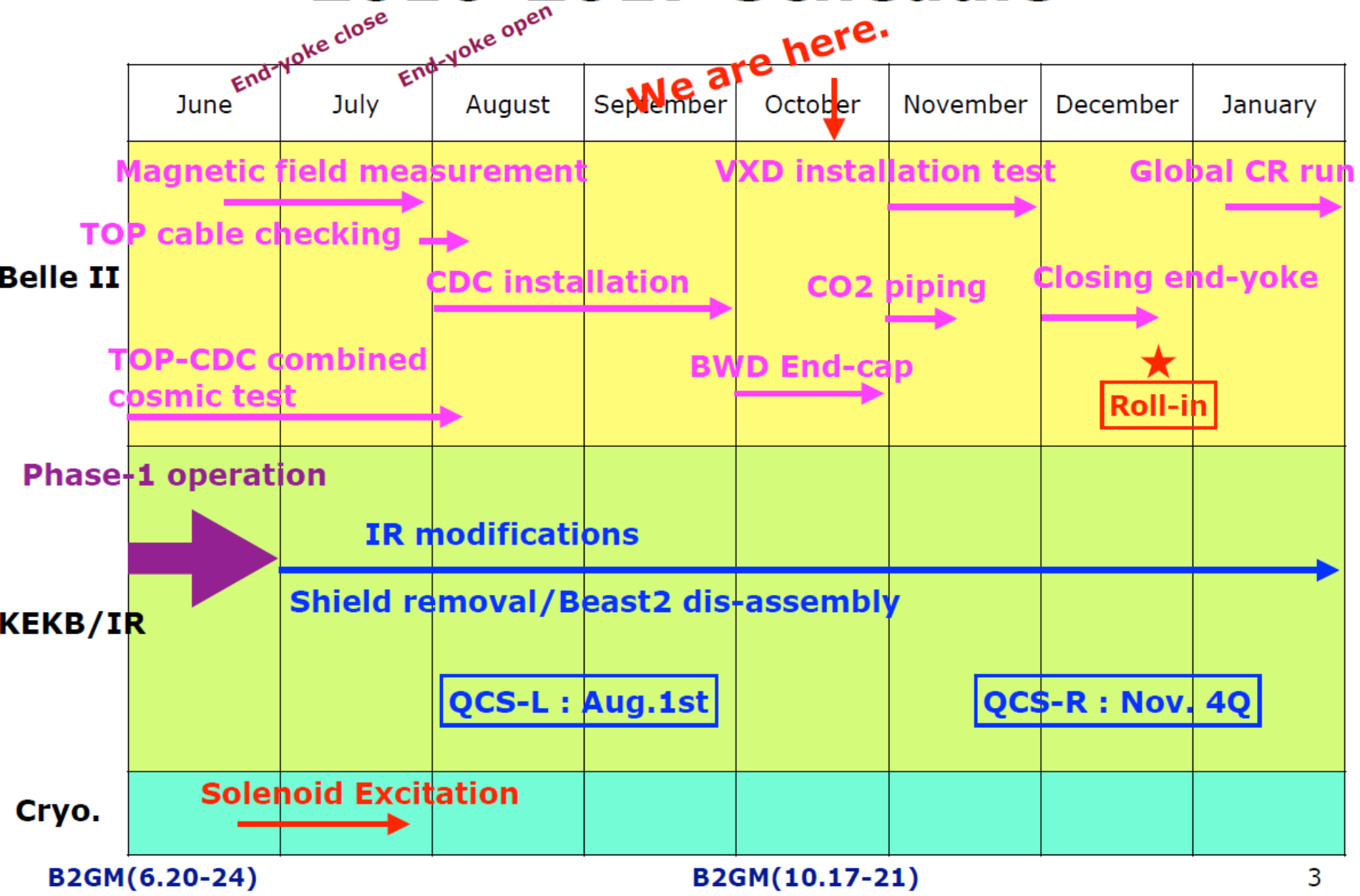

2016-2017 Schedule

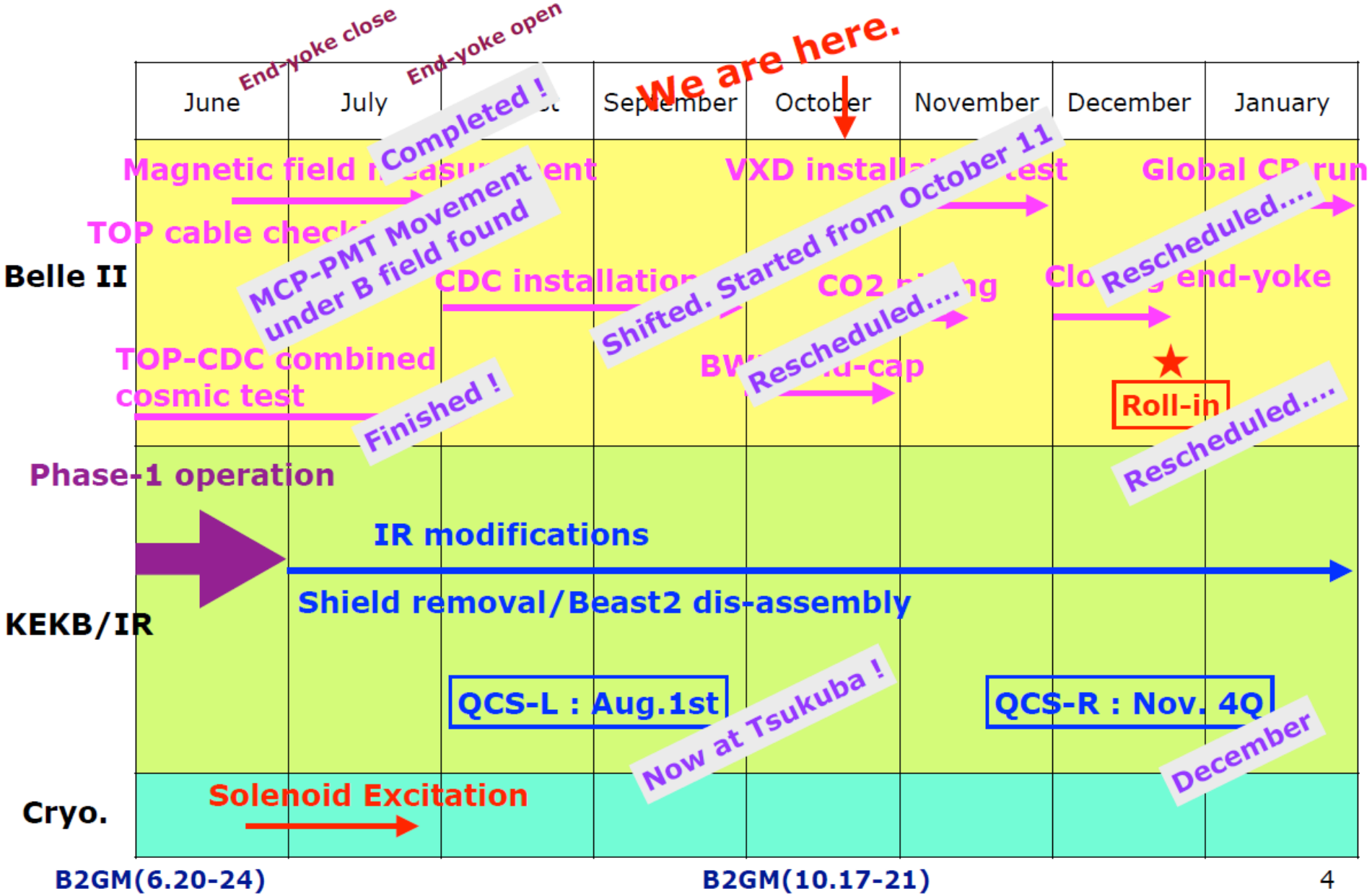

2016-2017 Schedule

We are here.

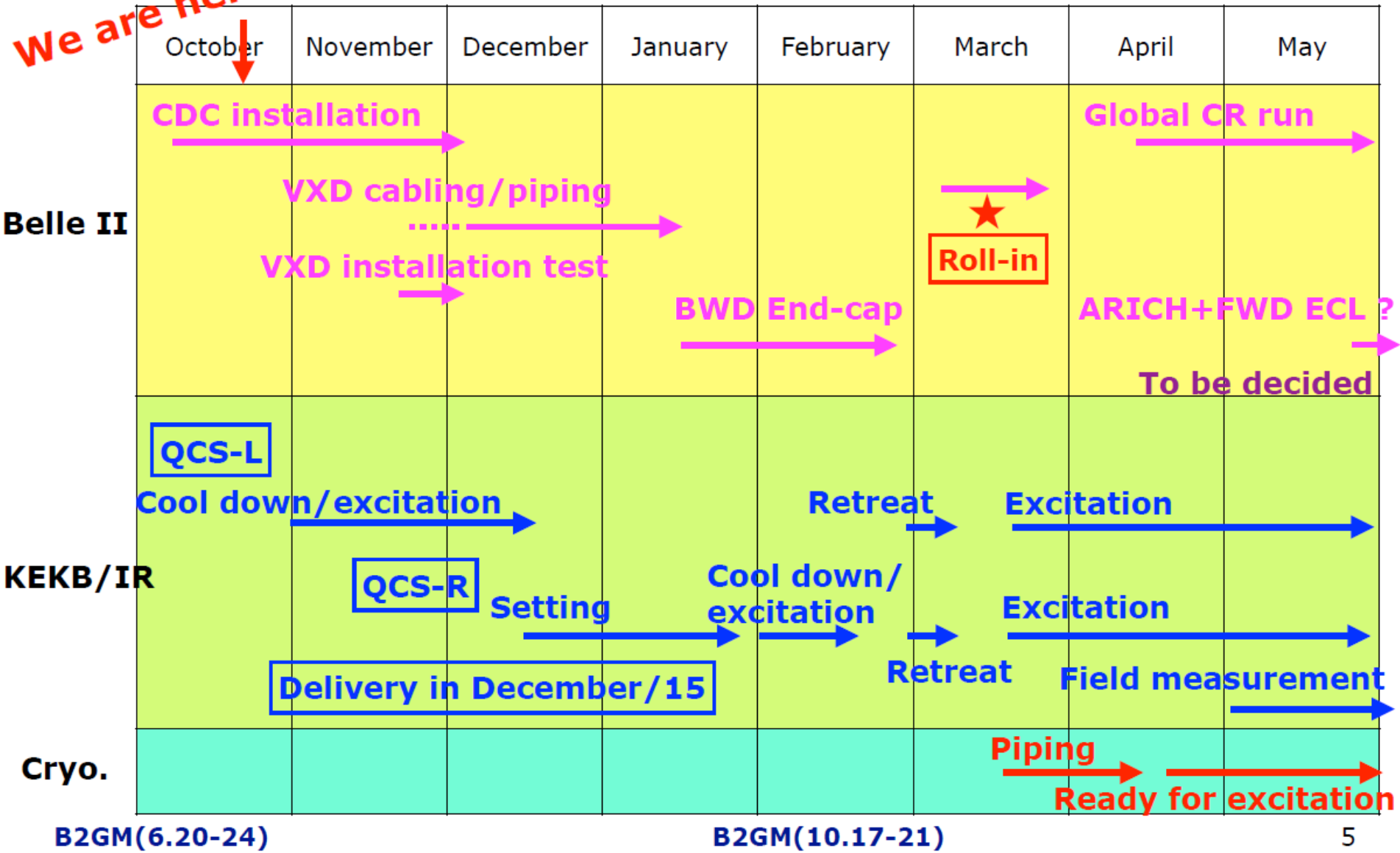

B2GM(6.20-24)

B2GM(10.17-21)

SuperKEKB/Belle II Status

- **Commissioning** (Phase 1) of the main ring (without final quads) **successfully carried out from Feb 1, 2016 – end of June!** Interaction point detector: instead of Belle II, a commissioning detector – Beast II.
- Add **final quads** in until **end of 2016**
- Belle II: installation of outer detectors: spring – december 2016
- Belle II (without the vertex detector) **roll in March 2017**, cosmic rays
- Phase 2 commissioning Nov 2017 – spring 2018 (+ first physics runs)
- **Install vertex detector summer 2018**
- **Full detector operation by the end 2018** (Phase 3)



SuperKEKB Schedule

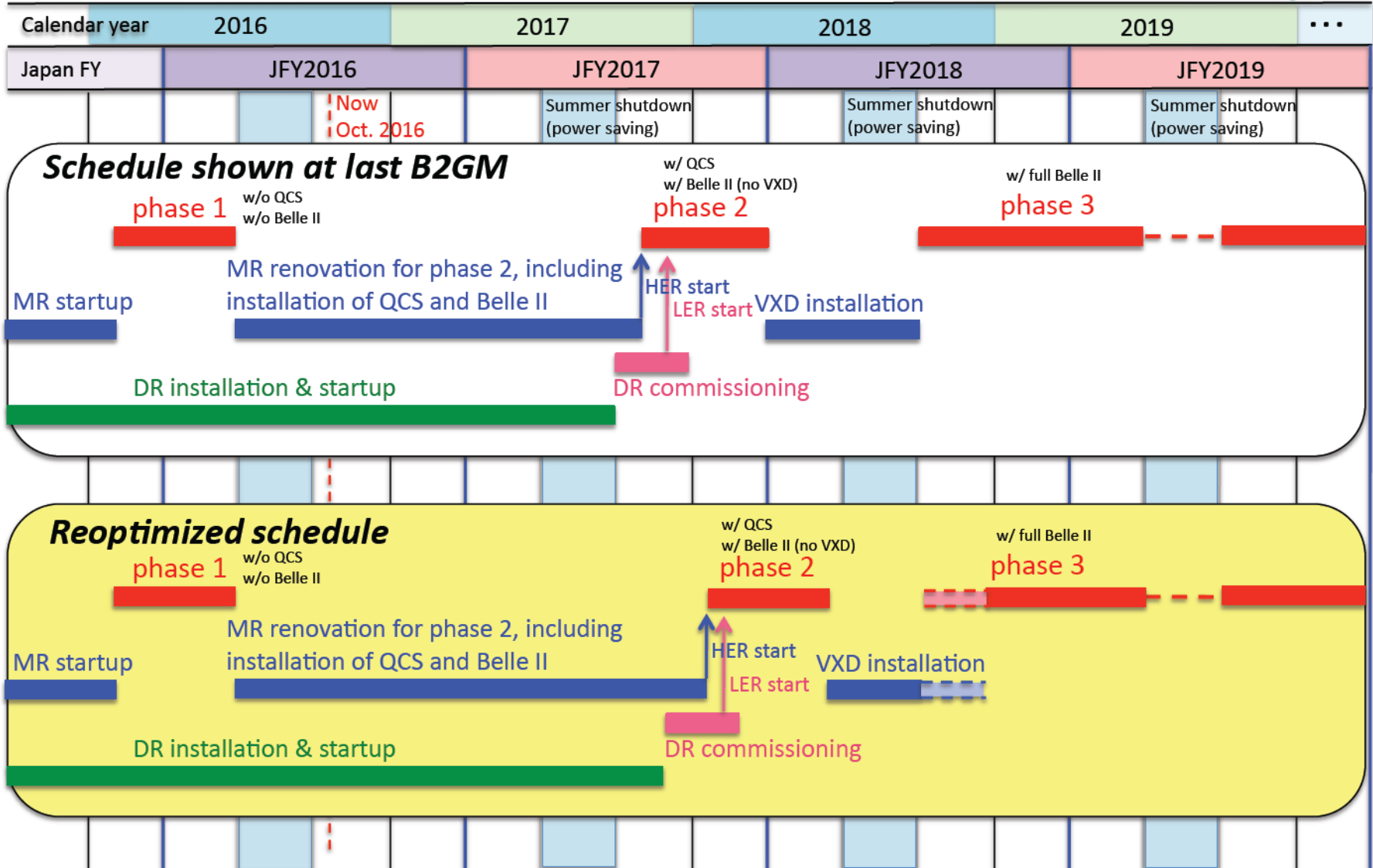



SuperKEKB + Belle II Schedule



| Calendar year | 2016 | 2017 | 2018 | 2019 | ... |
|---------------|------------------|-----------------------------------|-----------------------------------|-----------------------------------|-----|
| Japan FY | JFY2016 | JFY2017 | JFY2018 | JFY2019 | |
| | Now Oct. 2016 | Summer shutdown (power saving) | Summer shutdown (power saving) | Summer shutdown (power saving) | |

Belle II commissioning

CDC cosmics

Global cosmics

w/o FW-ECL
and ARICH

w FW-ECL
and ARICH

Collisions

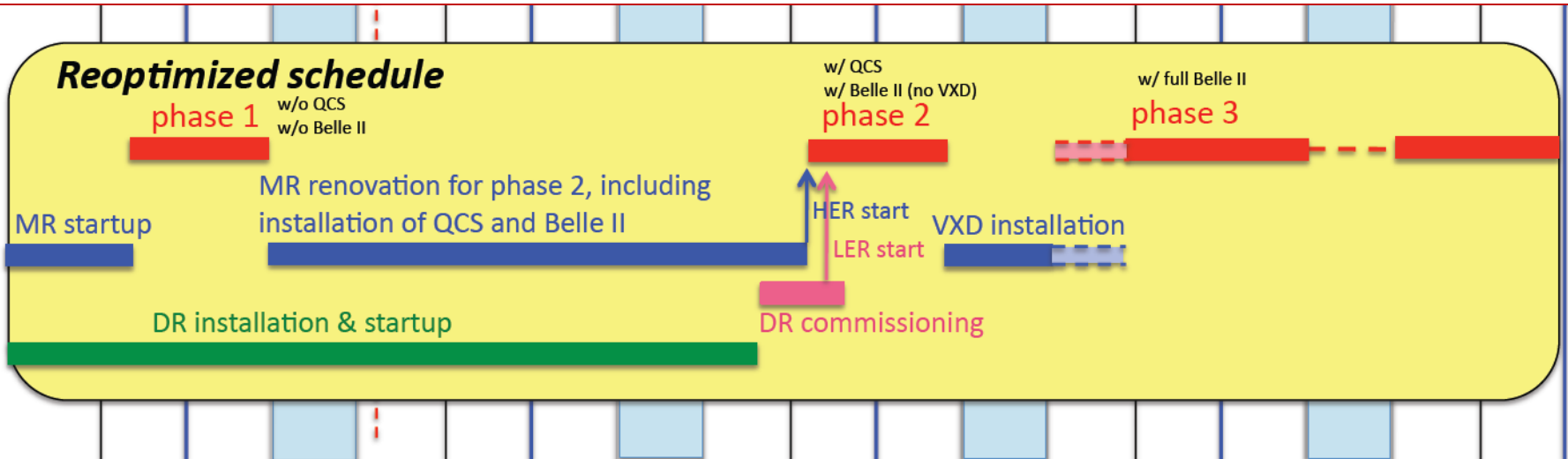

SuperKEKB/Belle II Status

- **Commissioning** (Phase 1) of the main ring (without final quads) **successfully carried out from Feb 1, 2016 – end of June!** Interaction point detector: instead of Belle II, a commissioning detector – Beast II.
- Add **final quads** in until **end of 2016**
- Belle II: installation of outer detectors: spring – december 2016
- Belle II (without the vertex detector) **roll in March 2017**, cosmic rays
- Phase 2 commissioning Nov 2017 – spring 2018 (+ first physics runs)
- **Install vertex detector summer 2018**
- **Full detector operation by the end 2018** (Phase 3)

SuperKEKB luminosity projection

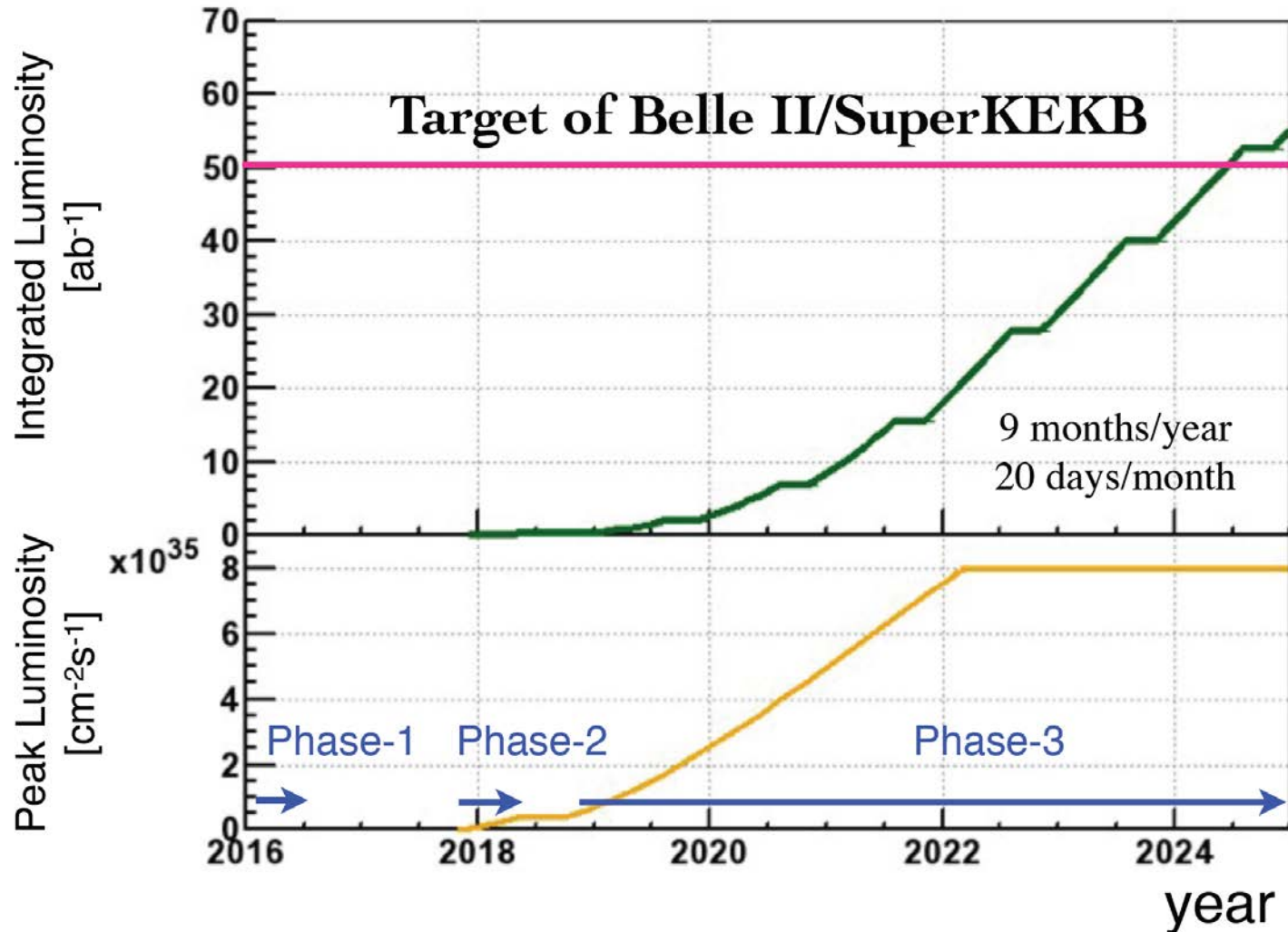

Summary

Detector construction well underway

Accelerator: in December expect delivery of the one missing piece, one of the two final quads.

First data taking in spring 2018

Main physics run starts end of 2018.

Will do our best to provide you with data asap!

More slides
