

Power Supply

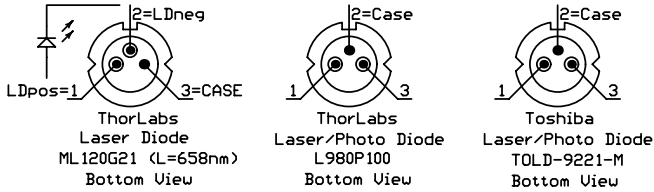

Oscillator

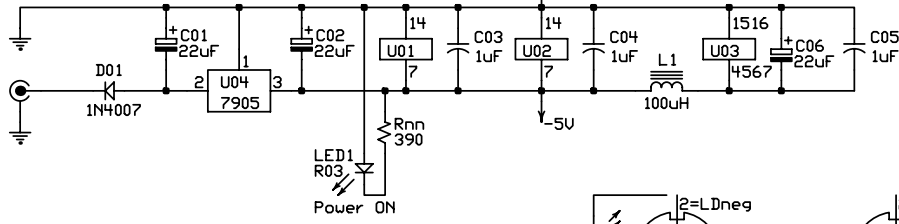
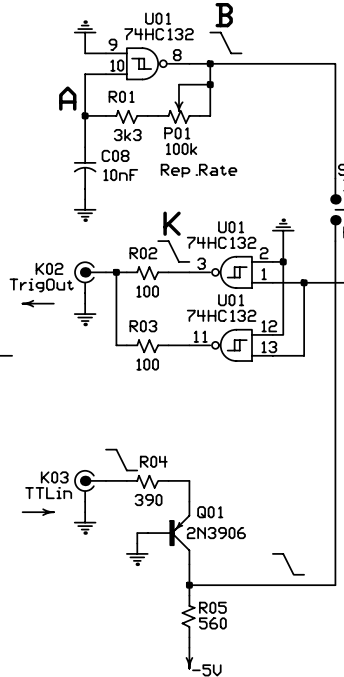

Pulse Generator

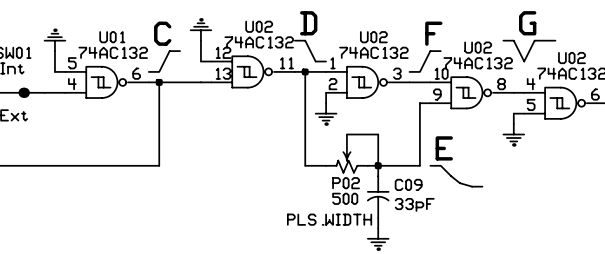

Driver

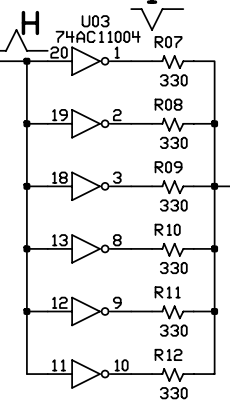

Timing 1

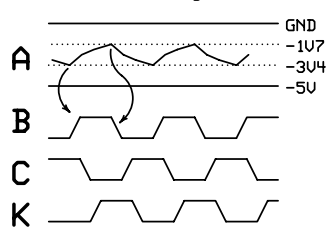

Timing 2

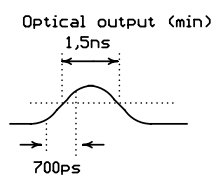
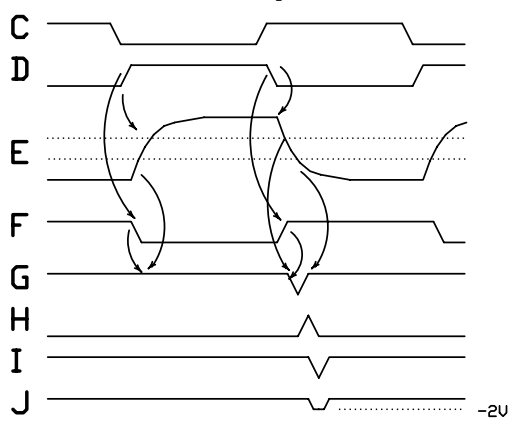

Institut Jožef Stefan

projekt/naloga :	LASER Pulse Driver			
sestavni del :	Pls Gen & Drv	načrtoval	E. Margan	
pripombe :	tolerance uporov	1 %	datum	1998.01.12.
	tolerance kondenzatorjev	20 %	prenova	2005.10.24.
			datoteka	LASER_PG.SCH

