

Layer 8 (Bottom + Shield)

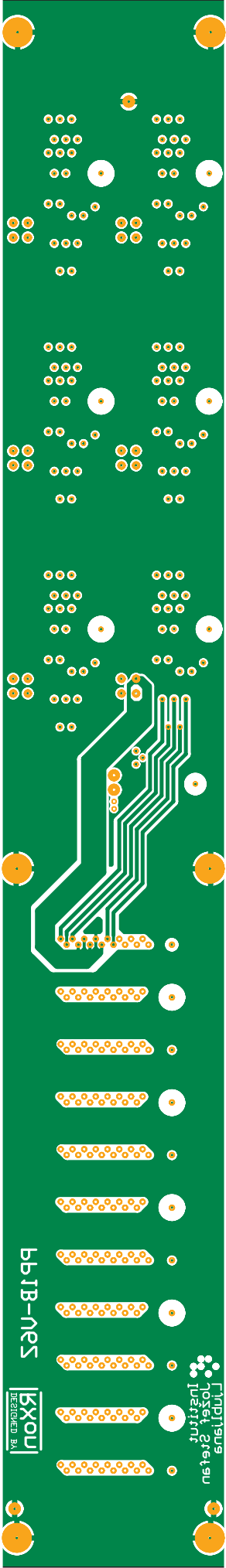

Layer 2 (inner + Shield)

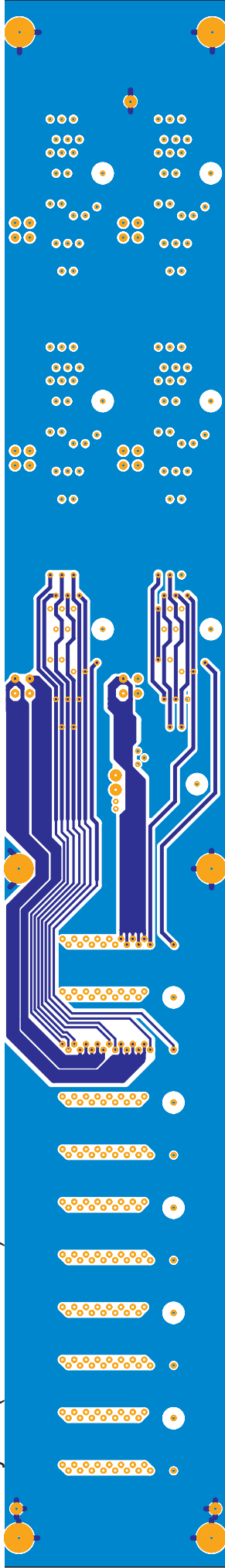

Layer 1 (Top, Component Side + Shield)

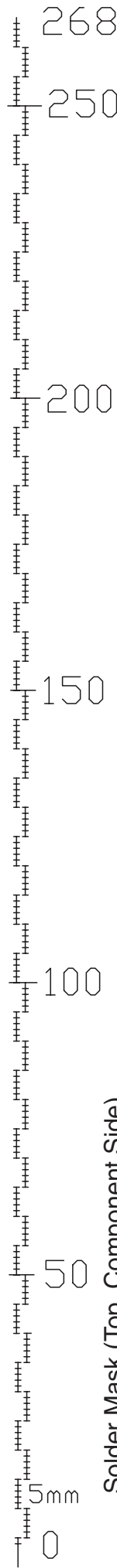
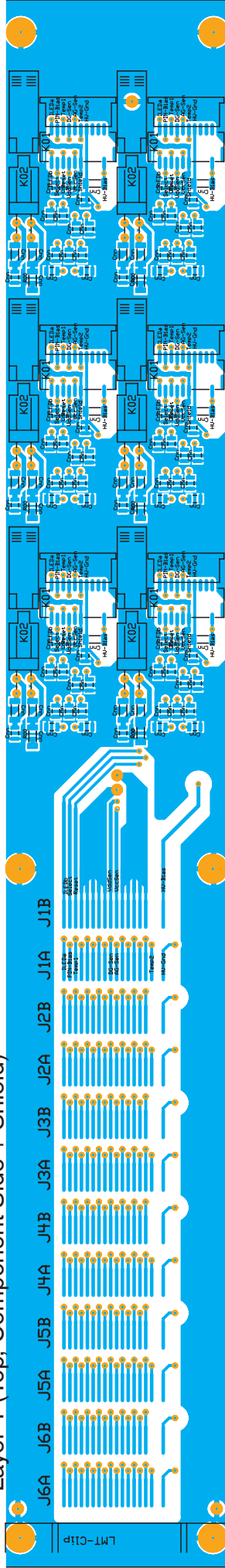

Solder Mask (Top, Component Side)

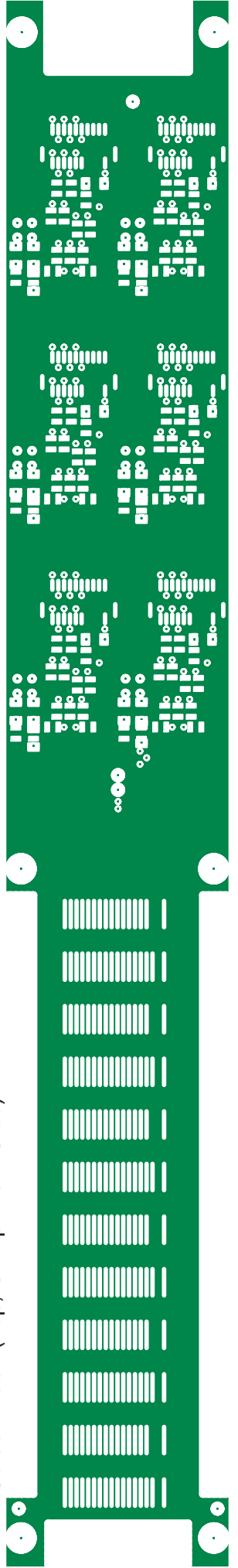

Layers 5 & 6

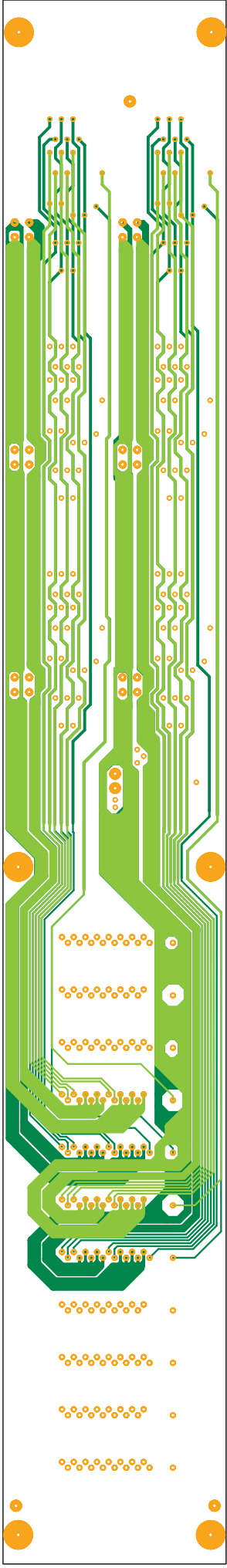

Layers 3 & 4

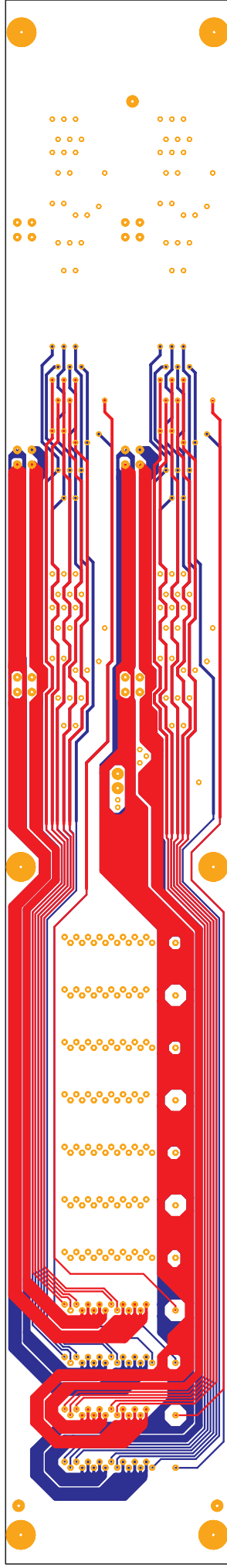

Layer 7

